

Water Department  
By-laws and Regulations

Effective January 20, 2025

Michael Snider  
Mayor

Tracy Colston  
Safety-Service Director

Dina Shenker  
Law Director

**CITY OF PORT CLINTON  
WATER REGULATIONS**

**TABLE OF CONTENTS**

APPLICABILITY	1
DEFINITIONS	1
UTILITIES ADMINISTRATION	
CHAPTER 100 - GENERAL ADMINISTRATION	6
CHAPTER 101 - CONTRACT FOR UTILITY SERVICES	7
CHAPTER 102 - CUSTOMER OBLIGATIONS	11
CHAPTER 103 - SERVICE DISCONNECTIONS	12
CHAPTER 104 - BILLING	17
CHAPTER 105 - APPEAL PROCESS	20
CHAPTER 106 - COLLECTIONS	22
CHAPTER 107 - TYPES OF ACCOUNTS	24
WATER DISTRIBUTION	
CHAPTER 200 - WATER SERVICES (TAPS AND CUSTOMER BRANCHES)	25
CHAPTER 201 - METERS	29
CHAPTER 202 - FIRE PROTECTION SERVICES	37
CHAPTER 203 - PUBLIC HYDRANTS	42
CHAPTER 204 - CROSS CONNECTIONS	44
CHAPTER 205 - WATER SERVICE MAIN EXTENSIONS	53

CHAPTER 206 -	REGULATIONS FOR CONTRACTORS	58
CHAPTER 207 -	RIGHTS OF ENTRY	59
APPENDIX A	WATER RATES	A-1
APPENDIX B	SCHEDULE OF FEES & CHARGES	A-2
APPENDIX C	STANDARD FORMS	A-3
APPENDIX D	STANDARD SPECIFICATIONS & DRAWINGS	A-4
APPLICABILITY		1
DEFINITIONS		1
CHAPTER 100 General Administration		6
100.01	Contact Information	6
100.02	No guarantee	6
100.03	Tampering And Unauthorized Use And Theft of Utility Services	6
CHAPTER 101 Contract for Utility Services		7
101.01	Agreement To All Applicable Laws, Rules And Regulations	7
101.02	Application	7
101.03	Red Flags Rule Compliance Statement	10
101.04	Turning on Water Service	10
CHAPTER 102 Customer Obligations		11
102.01	At The Premises	11

102.02	Property Transfers	11
CHAPTER 103		
	Service Disconnections	12
103.01	Nonpayment	12
103.02	Discontinuation of Service and Billing	13
103.03	Killing Service	13
103.04	Notification of Water Turn off in Mains	15
103.05	Stoppage of Water Service Because of Leaks, Etc.	15
103.06	Additional Reasons	15
103.07	No Charge for Water to Municipal Departments or Buildings	16
CHAPTER 104		
	Billing	17
104.01	General	17
104.02	Billing for Utility Service is Continuous	18
104.03	Reading of meters, Billing and Collection Procedures of the Port Clinton Water and Sewer Departments	18
104.04	Estimated Bills	19
104.05	Adjustment of Bills	19
104.06	One Time Penalty Waiver	20
CHAPTER 105		
	Appeal Process	20
105.01	Customer Service	20
105.02	Management Review	21
105.03	Adjustment Committee	21

105.04	Administrative Hearing	21
CHAPTER 106		
	Collections	22
106.01	General	22
106.02	Statutory Liens	22
106.03	Collection Agents	22
106.04	Court Actions	23
106.05	Additional Remedies	24
CHAPTER 107		
	Types of Accounts	24
107.01	Regular Accounts	24
107.02	Sewer-Only Accounts	24
107.03	Hydrant Meter Accounts	24
107.04	Water Only Accounts	25
CHAPTER 200		
	Water Services (Taps and Service Connection)	25
200.01	Payment For Tap And Tap Branch	25
200.02	Installation of Tap and Tap Branch	26
200.03	Taps-Service Size-Materials	26
200.04	Repairs to Tap and Water Service Line (City's side)	27
200.05	Workmanship on Service Line (Customer's side)	28
200.06	Depth of Pipe	28
200.07	Customer's Water Service Line Location and Construction	28

200.08	Main Service Line Valves (Commercial)	28
200.09	Customer's Service Line Leaks	29
200.10	Defective Work	29
CHAPTER 201		
	Meters	29
201.01	Services To Be Metered	29
201.02	Service Not Required to be Metered	29
201.03	Meters - Number Allowed	30
201.04	Maintenance of Service; Determination of Meter Size; Installation of Meters	30
201.05	Meter Setting and Locations	30
201.06	Removal of Meters	32
201.07	Accuracy of Meters	32
201.08	Damaged and Worn Meters	32
201.09	Testing and Repair of Commercial Meters	32
201.10	Testing And Repair of Department-Owned Meters	33
201.11	Tampering With Meter or Related Appurtenances	34
201.12	By-Passes on Meter Settings	34
201.13	Touch Pad and Radio Transmitter	34
201.14	Charges - Remote Registers and Radio Transmitters	35
201.15	Metering Methods (including Alternate Metering)	35
201.16	Inquiries	36

CHAPTER 202	
Fire Protection Services	37
202.01	Application for Fire Protection System Service 37
202.02	New Fire Systems and Modifications to Existing Fire Systems 37
202.03	Changes in Fire Protection System 37
202.04	Fees for Tapping, Plan Review and Inspection 38
202.05	Consumption of Water from A Fire System 38
202.06	Water Supplies and Pressure 38
202.07	Violations 38
202.08	Drip or Blow-off Valves 39
202.09	Pipes, Etc., To Be Accessible For Inspection 39
202.10	Fire Pumps 39
202.11	Check Valves 39
202.12	Cross-Connection Control 40
202.13	Miscellaneous Appurtenances or Extensions 41
202.14	Maintenance or Repair 41
202.15	Test of Private Fire Protection System 41
202.16	Tests By Insurance Company Representatives 41
202.17	Fire Flow Tests By Insurance Company Representatives 42
202.18	Damage Due to Water Turn Off 42
202.19	Annual Report Required 42
CHAPTER 203	
Public Hydrants	42

203.01	Use Of Public Hydrants By Other Than Authorized Governmental Agencies	42
203.02	Use Of Public Hydrants By Authorized Governmental Agencies	44
203.03	Flow Tests on Public Hydrants	44
CHAPTER 204		
	Cross Connections	44
204.01	Cross-Connection Control & General Policy	44
204.02	Water System	45
204.03	Cross-Connections Prohibited	46
204.04	Survey And Investigations	46
204.05	Where Protection Is Required	47
204.06	Type Of Protection Required	48
204.07	Backflow Prevention Devices	48
204.08	Installation	51
204.09	Inspection and Maintenance	51
204.10	Booster Pumps	52
204.11	Violations	52
CHAPTER 205		
	Water Service Main Extensions	53
205.01	Location and Size Of Water Mains	53
205.02	Procedure For Extension Of Water Mains Within The City	53
205.03	Procedure For Extension Of Water Mains in Areas Outside the City Limits	56
205.04	New Subdivisions	57



CHAPTER 206	
Water Mains	58
206.01 Ownership and Maintenance of Water Main	58
CHAPTER 207	
Rights of Entry	59
207.01 Right of Entry onto Private Property	59
APPENDIX: A	A-1
APPENDIX: B	B-1
APPENDIX: C	C-1
APPENDIX: D	D-1

## **Revision Dates for the City of Port Clinton Water By-Laws**

The following is a list of the revision dates back to March 2012.

- \*3/2012 – Initial Rewrite of water by-laws
- \*1/16/13 – Minor amendments (see revised copy of by-laws)
- \*5/1/14 – Minor amendments (see revised copy of by-laws)
- \*4/15/16 – Clarify several sections and remove duplicate sections (see revised copy of by-laws)
- \*6/26/17 – Corrected 201.09 (B) from “Commercial meters over 1.5” are solely...” to “Commercial meters over 1” are solely...”
- \*1/29/18 – Updated Appendix A & Appendix B with 2018 rate structures
- \*10/18/19 – Revised Appendix D and several sections in Chapter 200 with regard to Standard Specifications and Backflow Protection. The following sections are included in this revision: 200.03, 200.04(E), 200.05(B), 200.09(B), 204.01(D), 204.06, 204.07, 204.09, 205.02(A)(4).
- \*1/20/2021 – Updated Appendix A, B and C with updated rates and forms. Fixed minor typo errors. Updated title page with new names (Tracy Colston – Safety Service Director, Dina Shenker – Law Director)
- \*1/20/2022 – Updated Appendix A & B with updated rates
- \*1/20/2023 – Updated Appendix A with updated rates and moved rate table from Appendix B to Appendix A
- \*1/20/2024 – Updated Appendix A with updated rates
- \*1/20/2025 – Updated Appendix A with updated rates

## **APPLICABILITY**

Pursuant to R.C. 735.02 and 743.02, the Director of Safety and Service has the authority to adopt rules and regulations which are necessary for the safe, economical, and efficient management of the public utility systems, including, without limitation, distribution, metering, billing, collecting, turn-on and turn-off procedures and such other measures required for fiscal integrity. These Rules and Regulations are assembled for customer and employee convenience and service. As provided in Section 743.02 of the O. R. C., these rules and regulations have the same validity as ordinances when not repugnant thereto.

Invalidity of any section, clause, sentence, or provision in these Rules and Regulations shall not affect the validity of any other section, clause, sentence, or provision of these Rules and Regulations which can be given effect without such invalid part(s). Any references to specific laws, ordinances, statutes, codes, regulations and similar documents shall be as same is amended or modified from time to time. The Director reserves the right to amend and/or revoke these Rules and Regulations in part or whole whenever he deems necessary or prudent. Not every situation can be listed or defined in these Rules and Regulations, and the inclusion or absence herein of any particular situation shall not be construed to limit the Director's authority to institute other practices or procedures as deemed necessary or prudent for the operation of the Water Department.

Every person, company, or corporation who uses water supplied to a premises shall, by taking such water, be considered as having expressed his or their consent to be governed by the Bylaws and Regulations. Any violation of these rules shall be reason for discontinuance of water service until such time as the matter in question shall be corrected to the satisfaction of the City.

## **DEFINITIONS**

The following non-exhaustive list contains terms used in these Rules and Regulations:

"Air Gap Separation" shall have the meaning set forth in OAC ' 3745-95-01 (A).

"Approved" shall have the meaning set forth in OAC ' 3745-95-01 (B).

"Auxiliary Water System" shall have the meaning set forth in OAC ' 3745-95-018).

"AWWA" shall mean the American Water Works Association.

"Backflow" shall have the meaning set forth in OAC ' 3745-95-01 (D).

"Bill" shall have the same meaning as Water Bill, Water and Sewer Bill, Utility Bill.

"Backflow Prevention Device" shall have the meaning set forth in OAC ' 3745-95-01 (E).

"CFR" shall mean the Code of Federal Regulations as same shall be amended or modified from time to time.

"City" shall mean the City of Port Clinton, a municipality of the State of Ohio and, where consistent with the context, its agencies, departments, divisions, boards, bureaus, officers and employees.

"City Code" shall mean the Port Clinton Ordinances as same shall be amended or modified from time to time.

"Consumer" shall mean the Person, Persons, firm or corporation having the use or benefits of Utility Services, see ' 101.01(A).

"Consumer Water System" shall have the meaning set forth in OAC ' 3745-95-01(H).

"Contamination" shall mean an impairment of the quality of the water by sewage, process fluid or waste to a degree which could create an actual hazard to the public health through poisoning or through spread of disease by exposure.

"Cross-Connection" shall have the meaning set forth in OAC ' 3745-95-01(I).

"Customer" shall have the same meaning as "Consumer."

"Degree of Hazard" shall have the meaning set forth in OAC ' 3745-95-01(J).

"Water Department" or "Department" shall mean the Water Department of the City.

"Director" shall be the City Director of Safety and Service or his/her designee.

"Director of OEPA" shall mean the director of the Ohio Environmental Protection Agency or his/her duly authorized representative.

"Double Check Valve Assembly" shall have the meaning set forth in OAC ' 3745-95-01(L).

"Double Check-Detector Check Valve Assembly" shall have the same meaning as set forth in OAC ' 3745-95-01(M).

"Easement" shall mean a grant by the owner of land for a specified use of land for the installation and maintenance of water lines and appurtenances for an indefinite period of time.

"Benefitted Unit Equivalency Factor" shall have the same meaning set forth in Code Section 911.03

"Fire Protection Service Connection" any connection to the water distribution system used for the purpose of fire fighting or fire protection.

"Health Hazard" shall have the meaning set forth in OAC ' 3745-95-01(N).

"Interchangeable Connection" shall have the meaning set forth in OAC ' 3745-95-01(P).

"Isolation Backflow Prevention Device" shall have the meaning set forth in ORC ' 3703.21(F)(1).

"Kill" shall mean the physical termination of Utility Services.

"Meter" shall mean any device that measures the flow or volume or consumption of Utility Services.

"NFPA" shall mean the National Fire Protection Association.

"Non-Potable Water" shall mean water not safe for drinking, personal, or culinary use.

"OAC" shall mean the Ohio Administrative Code, as same may be amended or modified from time to time.

"OEPA" shall mean the Ohio Environmental Protection Agency or his/her duly authorized representative.

"ORC" shall mean the Ohio Revised Code, as same may be amended or modified from time to time.

"Owner" shall be defined as the person who holds actual, not merely equitable, title to property. Executors, administrators of estates, and persons who hold property in trust shall be considered owners.

"Person" any individual, firm, company, association, society, corporation, or group.

"Potable Water" shall mean water which is satisfactory for drinking, culinary, and domestic purposes and meets the requirements of the OEPA.

"Power of Attorney" shall mean a legally valid and binding instrument by which the Customer confers to another the power to perform specified acts that include Utility Service matters.

"Premises" shall mean the real property that is the service address receiving Utility Services.

"Process Fluids" shall have the meaning set forth in OAC 3745-95-01(U).

"Public Water System" shall have the same meaning as ascribed to such term in ORC ' 6109.01(A) and 6109.02.

"Reduced Pressure Principle Backflow Prevention Assembly " shall have the same meaning as set forth in OAC ' 3745-95-01(W), as same shall be amended or modified from time to time.

"Reduced Pressure Principle-Detector Assembly" shall have the same meaning as set forth in OAC ' 3745-95-01(X).

"Resale of Utility Services" shall mean the authorized and metered sale of Utilities Services by a Customer to someone else, such as a tenant or resident, including, without limitation, private sub-metering.

"Service Connection" shall have the meaning set forth in OAC ' 3745-95-01(Y).

"Service Line" shall mean the pipe or conduit by which water is conveyed or drawn from the water main to the Customer's property. Large Service Lines are considered to be over 2" in size.

"Severe Health Hazard" shall have the meaning set forth in OAC ' 3745-95-01(Z).

"Split" shall mean a water service divided ahead of the meter to serve additional Customers. All customers shall have their own curb boxes to terminate individual service to a premises.

"System Hazard" shall have the meaning set forth in OAC ' 3745-95-01(BB).

"Tap/Water Tap" the physical connection (corporation stop) into the water main.

"Utility Services" shall generally mean any combination of services, or water that a given

Premises receives.

"Water Main (Distribution Water Main)" shall mean the principle piping or conduit owned and maintained by the City through which water is conveyed or drawn to private water mains and/or service lines. Note: Not all water mains are owned or maintained by the City. Some are privately owned and maintained.

"Water Service" Shall mean the readiness to supply or actual supplying of water for drinking, sanitation, or fire protection, etc. to a premises on which water service connection has been installed.

"Water Purveyor" shall have the same meaning as the "Director".

## **CHAPTER 100 GENERAL ADMINISTRATION**

### **100.01 Contact Information**

The City Water Department Customer Service office is available by phone Monday through Friday, except for holidays, from 8:00 a.m. to 4:00 p.m., as same may change from time to time. Walk-in office hours are 8:00 a.m. to 4:00 p.m., as same may change from time to time. The Department's address is 1868 E Perry Street, Port Clinton, Ohio 43452; phone number is (419) 734-5522. The Service Department hours of operation are 7:00 a.m. to 3:00 p.m., as same may change from time to time. The Service Department's address is 317 W Perry Street, Port Clinton, Ohio 43452; phone number is (419) 734-2623.

### **100.02 No guarantee**

The Department does not guarantee any fixed pressure or a continuous supply of water due to the varying conditions which may arise in the operation and maintenance of the water supply. The Department disclaims any responsibility for damages arising from the shutting off of a water main or for the shutting off of a supply of water to any Premises for any reason. The Department disclaims any responsibility for damage by water to any personal or real property caused by leaks of broken or open pipes, meters or fixtures.

### **100.03 Tampering And Unauthorized Use And Theft of Utility Services**

A. The Department enforces, without limitation, ORC Chapter 4933 as each may be amended from time to time. Actions which constitute a theft offense and/or violations of the above-mentioned statutes include, without limitation: unauthorized connection, reconnection or disconnection of Utility Services; receiving Utility Services without receiving a bill and/or without paying for same; removing or reversing a meter; tampering with or unauthorized bypass of a meter; tampering with locks and locking valves and seals; illegal water taps and sewer connections; disconnections of the remote register or radio transmitter; unmetered hydrant usage; or tampering with public or private valves, stop cocks, apparatus or facilities or the breaking of

seals that result in obtaining Utility Service without authorization from the Department.

B. Violation may result in prosecution, criminal sanctions, the termination of Utility Service without notice, assessment of investigation and other costs related to the termination of Utility Service, penalties, unauthorized use of services charge(see Appendix “B”), automatic forfeiture of any deposits, restitution, back billing for metered and/or unmetered Utility Service, and/or criminal prosecution. Each violation may incur separate, cumulative remedies.

## **CHAPTER 101 CONTRACT FOR UTILITY SERVICES**

### **101.01 Agreement To All Applicable Laws, Rules And Regulations**

A. The Department provides its Utility Services to qualifying Owners of a Premises that hold a valid contract in good standing with the Department. No Owner or occupant of a Premises is entitled to receive Utility Services at the Premises. For purposes of these Rules and Regulations, a contract for service may also be referred to as an agreement or an accepted application. The Department may intermittently in these Rules and Regulations and in practice refer to the valid recipient of such Utility Services as a Consumer, Customer, contract holder, Owner or business partner. Tenants, lessees or similar non-contracting parties with the Department are neither Customers nor third-party beneficiaries of a Customer.

B. Acceptance and/or receipt of Utility Services shall constitute a knowing and voluntary agreement by the recipient to be bound by all applicable laws, rules and regulations, as may currently exist or as may be changed from time to time, contained herein, in the ORC, City Code or elsewhere.

C. No oral modification to the agreement is permitted nor shall any such modification be binding on the City. Written modification to the agreement shall only be permitted if on the Addendum to the Owner Contract form (see Appendix “C”).

D. Any requests for an address change must be done in writing.

E. In exchange for obtaining Utility Services from the City, a Customer agrees and acknowledges that the receipt of Utility Services at the Premises is for the Owner's occupation or the Owner's authorized representative's occupation and that for the purposes of ORC ' 743.04 is the Owner who occupies the Premises served.

### **101.02 Application**



A. Prior to any access to Utility Services, including, without limitation, taps and tees to utility lines, the Owner must apply for said Utility Services. An application for Utility Service shall be completed by the Owner and shall be made in the manner specified by the Department from time to time. Some requirements include, without limitation: providing valid identification; providing proof of ownership; and satisfaction of any and all outstanding charges related to the Premises that is the subject of the application and/or other properties owned by the applicant or other applicant accounts. The application must be signed by the Owner or by the Owner's legally authorized agent. In the event that more than one Person or entity owns the Premises, for example, a husband and wife, all Owners will be jointly and severally liable for the charges on the account or attributable to the Premises served. By submitting an application for Utility Services or accepting Utility Services, the applicant/recipient represents and warrants to the Department that the applicant is the lawful Owner of the Premises to receive Utility Services.

B. Applicants for Utility Services must sign a contract document that, if it does not spell out in full all of the laws, rules, regulations, policies and obligations that apply to Customers, it shall be deemed to incorporate same by reference. Notwithstanding the foregoing, the absence of a signature to a contract and/or the acceptance and/or receipt of Utility Services shall constitute a knowing and voluntary agreement by the recipient to be bound by all applicable laws, rules and regulations contained herein, in the ORC, City Code, or elsewhere, as may currently exist or as may be changed from time to time, including, without limitation, the cost of Utility Services. For the entire duration of accepting and/or receiving Utility Services, the applicant represents and warrants to the City and Department that the applicant is the lawful Owner of the Premises to receive Utility Services.

C. An Owner may be denied for reasons determined by the Department, including, without limitation: if the Owner and/or entities under Owner's control has delinquencies or owes fees for other properties, or if the Owner and/or entities under Owner's control has delinquencies or owes fees, etc., to the City for any matter.

D. Deposits.

1. The Department may require a Customer to furnish a deposit as a condition of application approval for any reason deemed to be in the best interests of the Department, including, without limitation: payment history, bankruptcy filings, foreclosure filings, or receiverships.

2. The amount of deposit required may vary, but will generally be equal to two (2) billing cycles' worth of charges. The Director may raise or lower the deposit at its discretion.

3. The Department may require an established Customer to furnish a deposit or an additional deposit, at its discretion, based on factors such as payment history, multiple insufficient funds checks and/or court filings.

4. The Department may apply a deposit as a credit to the account after a period of time as determined by the Department based on payment history and other relevant factors.

E. Trusts. When an application is made in the name of a title-holding trust or any similar Owner, the trustee shall provide the Department with a complete copy of the valid trust agreement applicable to the Premises that is the subject of the application. No Utility Service shall be provided to the Premises until a complete copy of the valid trust agreement is furnished and said trust agreement clearly authorizes the trustee or trustees to contract for and handle utility matters. In the event there is more than one trustee, only one need sign the contract for Utility Services unless the trust agreement indicates otherwise. If the trust expires, terminates or relinquishes its rights in the property to another, the new Owner must contract for Utility Service.

F. Condominium or Homeowner Associations. When an application is made in the name of a condominium ("condo") or homeowner association or any similar Owner, the condo or homeowner association shall provide the Department with a complete copy of the valid and recorded association documents applicable to the Premises that is the subject of the application. No Utility Service shall be provided to the Premises until a complete copy of the valid and recorded association documents are furnished and that said documents clearly authorize the person making application to contract for and handle utility matters. If the association documents expire or terminate, the new Owner must contract for Utility Service.

G. The Department reserves the right to require existing Customers to sign or re-sign a contract for Utility Services in the event the original contract cannot be located or as required by the Department.

H. Land Contract. Land contract vendors, as the Owners of the Premises, are required to contract for Utility Services for any properties being sold via land installment contract. The vendee is not the Owner for purposes of water service. Land contract vendees may only apply for Utility Services in the vendee's name if the following conditions are met: 1) vendor refuses to contract for Utility Services or defaults on the Utility Services, 2) vendee provides the Department a complete copy of the valid and recorded land installment contract highlighting the portion that specifically states that the vendee shall be responsible for paying the bills for Utility Services, and 3) the vendee deposits at least two (2) months usage, as determined by the Department, to ensure payment of Utility Services.

I. Landlord/Tenant Contract. At one time the Department handled some landlord-tenant accounts under a so-called Landlord/Tenant Contract. This practice is no longer offered for new accounts. Existing Landlord/Tenant Contracts may continue until the Department so notifies the Customer, or the service to the premises is changed. If the tenant is contractually obligated to pay the water and sewer bills under a pre-existing Landlord/Tenant Contract, both the tenant and the owner of the service address will receive delinquent bills and mailing regarding the service

address.

J. Information regarding an application or account is confidential, except where disclosure is required: under applicable public record laws; federal, state or local laws; for authorized law enforcement or postal authorities; for collection purposes; or when authorized by the Customer.

K. For all utility service provided by the City, the Property Owner of record of the real estate to which the water and/or sewer service is furnished shall be responsible for the payment of all water bills for such service, irrespective of who incurred such unpaid bills or when such bills were incurred, or who occupied the property at the time the bills were incurred. All unpaid water bills may be assessed as a tax lien against the property served, collectable according to law. A flat rate lien charge will be added to the account when certified to the County Auditor.

### **101.03 Red Flags Rule Compliance Statement**

The Director has developed an identity theft prevention program pursuant to the Federal Trade Commission's Red Flags Rule, which implements Section 114 of the Fair and Accurate Credit Transactions Act of 2003 and tailored to the Department's size, complexity and the nature of its operations. The program contains reasonable policies and procedures to: (1) identify relevant Red Flags for new and existing covered accounts (as defined in the Red Flags Rule) and incorporate those Red Flags into the program; (2) detect Red Flags that have been incorporated into the program; (3) respond appropriately to any Red Flags that are detected to mitigate or prevent identity theft; and (4) ensure the program is updated periodically.

### **101.04 Turning on Water Service**

A. All Customers who are having service restored after a voluntary or involuntary turn-off shall provide access for the Department to read all meters. Service will not be turned on or restored unless and until access is provided to all meters and any delinquencies or applicable charges are paid.

B. Utility Services that have been turned off pursuant to these rules and regulations will not be turned on again until the cause of the turn off has been removed and all applicable charges and any delinquencies have been paid.

C. Utility Services to a Premises shall be turned on only by employees of the Department. If water service is found to be turned on without authorization, an Unauthorized Use Fee of two hundred dollars (\$200.00) will be charged to the account. In addition, the City reserves the right to a police report for theft of service.

D. Turn on shall be performed only during normal Service Department working hours, unless authorized by the Director, or his/her authorized representative. The Department will not

guarantee same day turn-on for delinquent accounts nor authorize overtime payment for same.

E. Property owners delinquent in payment for water and sewer service, meter or service reconnect will not be given water service to other properties owned or rented by them until all accounts owed by the applicant shall have been paid in full. Neither will water service be given to his agent for any property owned by the property owner who is delinquent.

F. Before service will be restored to the customer whose water service has been turned off, the account balance must be paid in full, in addition to turn-off/ turn-on charges and damages as prescribed by the Safety-Service Director. A security deposit may also be required by the Safety-Service Director.

G. The Department reserves the right in cold weather months to require proof that a Premises has the heat on and in working order before turning on the water services.

## **CHAPTER 102 CUSTOMER OBLIGATIONS**

### **102.01 At The Premises**

A. Customers shall be liable for any and all Utility Services, repairs, and damages which, in accordance with these Rules and Regulations, City Code, the ORC and applicable laws are the responsibility of the property Owner and/or Customer.

B. Customers must provide access for the Department to read all meters. Failure to provide such access may result in notification that a touch read meter or radio transmitter must be installed by the Department. Failure to comply will result in billing of an additional charge of not less than fifty dollars (\$50.00) for each successive estimated meter read and/or termination of Utility Service. After a remote register or radio transmitter is installed, the Department will still require periodic access to inspect the meter.

C. In the event of any discrepancy between the meter and the remote register or radio transmitter, the meter will prevail.

D. All Customers who are seeking to initiate or restore water services must comply with these Rules and Regulations, including, without limitation, Section 101.05, above.

E. Failing to provide access or failing to show up for a Customer-requested or Department-ordered appointment will result in service charges being levied to the account.

### **102.02 Property Transfers**

Closing an account: Sellers of property receiving Utility Services must contact the

Department with sufficient advance notice to request a final meter read, and arrange for payment of the final bill(s). Upon receipt of this information, the Department will calculate the final charges due, subject to unbilled consumption contemporaneous with the date of the final reading and issue a final bill showing all charges owed. Buyers of property must contact the Department to apply for Utility Services.

A. The Customer must arrange access to the Premises so that all meters can be read (Final reading) by the Department for calculation of the final bill. Failure to do so may result in a penalty fee of no less than fifty dollars (\$50.00) for forcing an estimated final bill to be produced. A correction of an estimated final bill will be made when an appropriate actual meter reading is obtained.

B. If a minimum amount of water has been used, the charge will be prorated for the proportionate part of the billing period which it covers, applied to the minimum rate or the unit price applied to the quantity of water used, whichever is greater.

C. Final bills are issued in the same manor to tenants/renters who will be moving out when there is a Landlord/Tenant Contract currently in place.

## **CHAPTER 103 SERVICE DISCONNECTIONS**

### **103.01 Nonpayment**

A. Utility Service charges not paid by the billing due date are considered delinquent and may result in turn off of Utility Services.

B. Tenants, lessees or similar non-contracting parties with the Department are not Customers, third-party beneficiaries of a Customer or the Department, contract holders or account holders. When an account becomes delinquent in tenant occupied service address of which the City has notice, the City will endeavor to notify the Tenant(s), at individual residence structures by service notice post cards, or by door hangers at the entrance ways or entrance doors to apartments or units (where said doors are publicly accessible) to all known premises served by the account, that they are facing termination of service within 10 days. The notification will state that the tenant must enforce his/her/their civil and contractual rights through the court system in order for the City to stop termination of service proceedings. They will be advised that if they are unable to afford legal assistance to apply for free legal advice from ABLE. If the Port Clinton City Water and Sewer Department is notified by the Ottawa County Municipal Court or by a valid court order that the owner is contractually obligated to pay the water and sewer bill, the City will allow sixty (60) days from the date of such notification, for the landlord/owner to pay, or for the tenant to take all available actions necessary to enforce the court's order. In the event payment is still delinquent on the expiration of sixty (60) days, the City may terminate service at the service address. Tenants, lessees or similar non-contracting parties who have had

the water turned off at the structure where they reside may choose to seek legal advice regarding landlord-tenant, bankruptcy, estate, receivership and/or foreclosure laws that might impact the property Owner.

C. In the case of older existing private water systems where more than one party is supplied with water from the same service pipes, and one of the parties so supplied fails to pay the bills when due, or fails to comply with the “Rules and Regulations” the water may be shut off from such service laterals without City liability in damages to any of the other parties serviced by such service laterals. Where this type of service becomes a source of problem or dispute see Section 200.04 (E)

### **103.02 Discontinuation of Service and Billing**

Water service and water billing may be discontinued to a property, at the property owner’s written request, by completing a Discontinuation of Service and Billing form in the office of the Department. (See Appendix C)

In order to qualify for Discontinue of Service and Billing the City must verify the following:

- The owner of the property has signed a Discontinue of Service and Billing form
- There was zero (0) consumption registered through the water meter for a minimum of twelve (12) consecutive months.
- The account balance has been paid in full in addition to a turn off fee (if not already paid)

Upon the service being discontinued, the meter will remain in place and be read monthly. If unauthorized usage is discovered, billing will be re-activated and a fee of two hundred dollars (\$200.00) will be charged for the “Unauthorized Use of Service.” Any and all water used in addition will be billed in the next billing cycle. Monthly billing will resume until Discontinuation of Service and Billing is applied for again.

See section 101.04 for turn on regulations.

### **103.03 Killing Service**

A. A kill permit is required to kill the service and discontinue billing. Once the permit has been approved and the appropriate work has been done an appointment should be made for an inspection of the killed service. At that time the account will be finaled out and the bills will be discontinued.

B. Demolishing Buildings. A Permit to demolish a building must be issued by the Ottawa County Building Inspection Department prior to demolishing or moving a structure. Once a copy is received by the City, proper provisions must be made to Kill all water connections. A

Kill Permit must be obtained from the Department and the following must be adhered to:

1. For services larger than one and a half inches (1.5") in diameter, Kill will be performed by the Contractor.
2. For services one and a half inches (1.5") in diameter or less where water main shutdowns are not involved, Customers must receive a water Kill permit from the Water Distribution Department.
3. The Water Distribution Department may elect to perform Kills two inches (2") or less in diameter if circumstances so dictate. In this event, the Owner or contractor shall pay the standard fee to cover the cost of this work. No inspection fee is required if the Water Distribution Department performs this work.

C. The following procedures shall be observed by the contractor performing the Kill of any Utility Service:

1. The contractor may Kill Utility Services when using a construction box, roll services out of the way and reconnect the Utility Service when passed;
2. All Service Lines are to be plugged and capped to prevent Contamination;
3. The Customer is to be notified Twenty-four hours in advance by the contractor prior to the Kill and is to be served with water by hose if service is to be disrupted more than two (2) hours;
4. Water Distribution is to be notified and all Utility Services, whether they were Killed or not, shall be inspected and approved prior to the backfilling. The full circumference of the service pipe is to be available for inspection;
5. It is necessary to support the service pipe or water main across the ditch or other excavation in a manner approved by Water Distribution;
6. Any services that are backfilled prior to inspection shall be uncovered for inspection by Water Distribution at the contractor's cost. Where a service beyond a curb stop (toward the property) has been damaged and has been repaired by the contractor or his agent, the repair shall be inspected by Water Distribution before backfilling.
7. The contractor shall be charged for all expenses incurred by Water Distribution on this work, including inspection, correction of faulty installation, damage to piping and meters due to foreign material, and other necessary work;

D. When it is contemplated that Utility Service will again be needed on the property where

buildings are being demolished, a reasonable delay in the Kill may be granted; but, in no instance longer than one (1) year. However, Utility Service will not be granted if the service is of obsolete size, condition or material, or in poor condition as determined by the Department. An applicable deposit to cover the cost of the Kill must in all cases be made, regardless of whether or not a delay in Killing the service is granted.

E. Abandonment. An abandoned service, as determined by the Department, either on vacant or improved property that is connected to a water main may be Killed by the Department. The costs of removing any taps and infrastructure will be charged to the Owner of the property.

F. In the event of a catastrophic occurrence (i.e. fire, flood, tornado...) that severely damages or destroys a structure utilizing the City Water supply, the City will, upon notification from the property owner and/or verification from the Fire Chief that the structure is not inhabitable, shut off the public water supply and discontinue water billing until such time that a new structure is constructed. The standard repair permit and inspection fee shall be waived for catastrophic events that severely damage or destroy a structure to the point of being inhabitable. However, an inspection will be required to restore service.

G. In the event the property owner would decide to re-tap using the existing tap, there would be no additional tap fee. If the existing tap is not used, the current tap charge will be charged. An impact fee would only be charged if the use changes in a way that would cause the EDU's to be higher than the previous structure's EDUs.

#### **103.04 Notification of Water Turn off in Mains**

Before the water in a main line is turned off, for reasons of repairs or alterations, all customers affected will be notified, if possible. Notice shall be considered to have been given when and if some person at each address had been told, either in person or in writing, or door hanger of such action.

#### **103.05 Stoppage of Water Service Because of Leaks, Etc.**

In case of leaks or breaks, and/or failure in water mains, services, pumping and auxiliary machinery, the supply of water may be shut off without prior notice.

#### **103.06 Additional Reasons**

A. The Department may terminate Utility Services after notification by mail, service notice door hanger, electronic mail, telephone or in person for the following reasons:

1. Failure to comply with these Rules and Regulations;
2. Failure to provide access to all meters or for the presence of any animals deemed



hostile;

3. Delinquencies on any properties receiving Utility Services;
4. Cross connection or interconnection with any other supply of water when not approved by the Department. This includes installation of pipe and fixtures allowing the possibility of back-siphonage or backflow, in the opinion of the Director or his designated representative;
5. Failure to promptly repair leaking service line within forty-eight (48) hours after being notified of the problem;
6. Use of Utility Services on any Premises other than that recorded in the application, except as may otherwise be provided for;
7. Tampering with any service pipe, meter, curb stop, corporation stop, or any other appurtenance, or the seal on any appurtenance; or
8. As authorized by the Director.

B. Turn Off Without Notice. The Department may turn off Utility Services without notification for any of the following reasons:

1. Willful waste of water;
2. Making any additions or alterations in or about the Customer's service line without written Department permission;
3. Failure to complete all the application steps or to execute a proper contract for the supply of water.
4. Where property vacancy or abandonment is determined by the Department, or if, in the opinion of the Department, damage may be caused to building or to contents.
5. Notification that the Customer no longer owns the Premises;
6. Any situation deemed hazardous by the Department to the public health or safety;
7. Theft of Utility Services;
8. Failure to notify the Department of address or other changes that result in the Department's bills being returned;
9. Unpaid liened or lienable charges;

10. Charge backs or insufficient funds or other bad payment; or

11. As authorized by the Director.

C. The Department is not liable if a turn off is not performed at a specific date, time or manner.

### **103.07 No Charge for Water to Municipal Departments or Buildings**

The Director is hereby authorized to direct the Department to provide water free of charge to municipal departments when used for municipal purposes and the furnishing of water free of charge to such departments in the past is hereby approved. This Section is in compliance with O.R.C., Section 743.27.

## **CHAPTER 104 BILLING**

### **104.01 General**

A. Utility Services are billed monthly on a schedule determined by the Department. Payment due dates are indicated on every bill statement. Payments are applied to delinquent balances first and then via a posting sequence determined by the Department. If a charge is not paid in full by the due date, a late payment charge will be added.

B. Minimum billing is established based upon the current rate per meter size for monthly billing. In case two or more units are served by one meter, a charge shall be made for each unit as if a separate meter was installed with a separate minimum charge for each unit. No allowance will be made for periodic discontinuance of billing when the shut off is made by the owner, a customer or the City.

C. The first bill for a new water service account will be prorated on a daily rate or actual consumption whichever is more.

D. Billing based on metered use of Utility Services will ultimately be charged according to the meter reading which is presumed to be accurate unless proven otherwise by Customer.

E. The Department may always go back and bill for unbilled consumption without regard to the age of the consumption.

F. There is no time limit for the Department to discover and act on an advancing meter where the billing software shows the utility service was turned off.

G. While invoicing should occur regularly, if this does not occur, it is not a defense to a

Customer's responsibility for payment for Utility Services rendered to a Premises. Customers are not relieved of the obligation to pay for Utility Services because, for example, a bill is returned to the Department, the bill was not delivered or the bill was not otherwise received by the Customer.

H. Payments on Account by Tenant, or Someone other than Owner on Behalf of Owner. Payments on an account for water and/or sewer may be accepted by the City on behalf of the owner who owns the premises pursuant to the Rules and Regulations promulgated by the Director, under which the owner is responsible for the payment of water and/or sewer service for the specific premises, whether the premises are occupied by such owner, land contract vendee, lessee, tenant or occupant, or unoccupied.

I. Writing "payment in full" on a check that is less than the amount rightfully owed to the Department is prohibited and shall not constitute an accord and satisfaction of the Customer's obligations. Rather, "payment in full" checks accepted and cashed by the Department shall be without prejudice, and shall completely reserve any and all rights that the Department has in order to collect any unpaid balance.

J. Requests for discontinuance of service, in occupied premises in which the customer of record is not the property owner, will not be honored or accepted for such purposes as eviction, enforcing collection of rents, or as a result of differences between the property owner and the occupant.

#### **104.02 Billing for Utility Service is Continuous**

All charges, including minimum charges that accrue without any actual usage, shall be attributed to the Owner of record. On every account, Utility Service shall be continuous until one of the following applies:

1. Water service and water billing may be discontinued to a property, at the property owner's written request, by completing a Discontinue of Service and Billing form in the office of the Department. (See Section 103.02)
2. In the event of a catastrophic occurrence (i.e. fire, flood, tornado...) that severely damages or destroys a structure utilizing the City Water supply, the City will, upon notification from the property owner and/or verification from the Fire Chief that the structure is not inhabitable, shut off the public water supply and discontinue water billing until such time that a new structure is constructed. (See Section 103.03 (F))
3. A kill permit is required to kill the service and discontinue the bills (See Section 103.03)

#### **104.03 Reading of Meters, Billing and Collection Procedures of the Port Clinton Water and Sewer Departments.**

A. All accounts shall be read and billed monthly, or every other month (bimonthly), or as otherwise directed by the Safety-Service Director.

1. Whenever customers are located in an area which is annexed to the City, the immediate billing following annexation shall be charged at the rate applicable to the major part of the billing period.
2. Monthly, or Bimonthly billings of accounts shall be performed as follows:
  - a) During the month of billing all affected customers will have their meters read or estimated by Water Department personnel. If a read cannot be obtained, bills will be estimated and the property owner shall be required to have a remote type meter installed to insure proper meter readings for future periods.
  - b) The Office Personnel then, using the reads obtained, figure these bills during the same month and bill the first of the next month. All bills not paid in full by the due date shall be increased by 10% and the amount of the bill as so increased shall constitute the gross bill. If the bill remains unpaid 15 days after billing, the service covered thereby will be mailed a final notice extending service for approximately ten (10) more days before discontinuance of service resulting from a turn off.
3. See section 101.04 for turn on regulations.

#### **104.04 Estimated bills**

A. When it is not possible for any reason to read a meter, the amount of water used for that period is estimated using historical or comparable data. In no case shall the customer be billed less than current minimum charge, as per the existing schedule of rates.

B. Call backs to read meters, when missed because of inability to gain entrance to the Premises, will not be made unless specially authorized by the Director and may be subject to administrative charges.

C. A correction of estimated bills will not be made until an actual meter reading is obtained. An adjustment will be made to the account to charge for unbilled consumption. There is no time limit for the Department to discover unbilled consumption and to back bill for same. Refund of a verified overpayment will be credited to the Customer's account. If the Customer terminates the Utility Service account, any refund due will be credited on the final bill. At the discretion of the Department, credits on one account may be transferred to another held by the contract holder or added to the current account for the Premises.

D. The Customer is solely responsible for reading every bill and being aware of the Customer's consumption patterns. If Customer observes more than two (2) consecutive estimated bills, it is incumbent on the Customer to contact the Customer Service to discuss the matter.

E. The Department may require relocation of the meter or terminate Utility Services and pursue all applicable collection actions if a Customer repeatedly fails to provide access to read all meters.

#### **104.05 Adjustment of Bills**

All Utility Service that passes through a meter shall be charged regardless of whether it was used, wasted, or lost by leakage. The Customer is solely responsible for reading every bill and being aware of the Customer's consumption patterns. In some circumstances, charges may be adjusted as determined by the Director, such as:

A. An inaccurate meter in accordance with AWWA standards;

B. An unwarranted billing of the account;

C. Sewer charges for water that is shown not to have returned to the sewer due to a proven leak. A Sewer Adjustment Form must be filled out and signed in order to receive a credit to your account. One sewer adjustment per year will be allowed unless deemed necessary at the discretion of the Department by showing proof of additional leaks. Customers that do not repair leaks in a reasonable amount of time will not be given credit for multiple months of high usage.

D. An adjustment as authorized by the Department.

E. Residential Auxiliary Sewer Deduct Program (See Section 201.15 (C) (2))

#### **104.06 One Time Penalty Waiver**

Customers contesting the 10% late penalty charged to their account(s) may be granted a one (1) time waiver of said charge during a one (1) year period providing the following conditions are met:

1. Requests for waiver must be submitted in writing (see form in Appendix C - Forms), signed and dated by the property owner or person on record with the Department as being responsible for payment; and,
2. Penalty has not been charged within a one (1) year period prior to the request (regardless of the occupant); and,
3. All delinquent charges for water and/or sewer service shall be paid in full prior to the

- next billing cycle for said service.
4. Request must be received within 30 days of being charged.
  5. Submitting a request will not prevent termination of water service.

## **CHAPTER 105 APPEAL PROCESS**

### **105.01 Customer Service**

Customers who question or dispute any charges on the Department's utility bill should contact the Water Department Customer Service office for clarification or correction of disputed charges.

### **105.02 Management Review**

A. If the dispute was not resolved by Customer Service, that Customer may write a letter of appeal to the Director explaining how Customer Service failed to follow the Department's Rules and Regulations or applicable law or how the denial ignored evidence that demonstrates an adjustment is warranted. The letter must be received by the Director no later than thirty (30) days after the denial was issued.

B. The Director will review such appeal letters and render a decision.

### **105.03 Adjustment Committee**

A. If the dispute was not resolved with the Management Review the Customer may write a letter to the Department's Adjustment Committee. The letter should clearly set forth the issue or issues in dispute, the basis for seeking an adjustment, along with any proof, such as copies of bills, necessary to help the Committee understand the basis for and support for the Customer's claim.

B. The Adjustment Committee will review the Customer's letter and supporting documents and render a decision. A letter or other written communication such as a corrected bill is then sent to the Customer explaining the approval, partial approval/denial or denial of the claim.

C. The Adjustment Committee is generally made up of representatives from the City's Departments of Utilities, including a representative of the Water Billing Department, a representative of Water Distribution, and a representative of the Waste Water Treatment Department.

### **105.04 Administrative Hearing**

A. If a Customer who receives an Adjustment Committee denial believes in good faith the denial was in error, that Customer may write a letter of appeal to the Director to request an administrative hearing and must explain how the Adjustment Committee failed to follow the Department's Rules and Regulations or applicable law or how the denial ignored evidence that demonstrates an adjustment is warranted. The letter must be received by the Director no later than thirty (30) days after the Adjustment Committee denial was issued. In order for the hearing to be granted the Customer must demonstrate that the Adjustment Committee and director failed to follow the Department's Rules and Regulations or applicable law or that the denials ignored evidence that demonstrates an adjustment is warranted. Hearings will generally not be granted if a Customer merely does not like the previous rulings and no justification exists to provide an adjustment.

B. At an administrative hearing, the Customer will bear the burden of proof. The Customer will present his or her case at the administrative hearing and provide all proof or documentation to justify the claim for relief. The Department will also present a case that responds to the Customer's case. The administrative hearing will be presided over by an Administrative Hearing Officer.

C. Decisions of the Administrative Hearing Officer are final non-appealable orders.

## **CHAPTER 106 COLLECTIONS**

### **106.01 General**

The Department reserves the right to pursue collection of all outstanding charges until full and complete satisfaction of all charges occurs, using any and all methods available to it. The Department need not elect any particular remedy and may concurrently pursue all collection methods available to it. These methods may involve actions taken against the account, the Premises and/or the account holder, including, without limitation: adding late charges, termination of Utility Services at the Premises or other address held by the Customer, transfers to other accounts, perfecting liens, adding lien charges, referrals to a collection agency, adding collection agency costs and fees, legal action and any other actions deemed necessary or appropriate. All costs incurred to implement these methods will be charged to the Customer, including, without limitation: administrative charges, court filing fees, attorney's fees and collection agency fees. Where the names of Customers may appear different, but common control is exercised among such Customers, the Department may treat such Customers similarly for the purposes of these Rules and Regulations.

### **106.02 Statutory Liens**

One method of collection of delinquent charges used by the Department is an in rem lien process that can involve open or closed accounts. Such delinquent charges are inchoate and/or

choate statutory lien(s) that attach to the Premises served at the time of rendering the relevant Utility Service. Perfection of these liens is prescribed by applicable law, and the Director certifies the charges to the appropriate County Auditor's office for processing, unless the lien is self-perfecting. The Director may also choose to certify self-perfecting liens to the appropriate County Auditor's office. Once a lien is certified to the County Auditor, payments for such lien must be made to the County unless the Department specifies otherwise. In no event shall payments made to the Department avoid any related lien charges or penalties. Liened accounts may still be subject to turn-off or any other remedy until the delinquencies are paid-in-full as determined by the Department.

### **106.03 Collection Agents**

The Department may use in-house staff or one or more outside agencies to handle collection agency work. An outside collection agency will be permitted to add its fees to the Customer's delinquency. Once a Customer's account is turned over to such an agency a Customer must pay to the agency the entire delinquency and all agency fees and charges. Attempts to avoid the agency's fees by submitting payment only for the utility charges to the Department will not be permitted and may result in the outstanding agency fees and any related interest or penalties being added to the Customer's account or another account consistent with these Rules and Regulations.

### **106.04 Court Actions**

A. Foreclosure. Whenever a Customer is the principal in a foreclosure that results in a judicial sale of the Premises, the Customer must supply the department with legal documentation stating the new legal owner of the property and arrange for an actual reading of the meter. The new Owner must then enter into a new contract with the Department. Failure of either the Customer or the new Owner to comply with these Rules and Regulations may result in termination of Utility Services without further notice and collection activity by the City.

B. Bankruptcy. Whenever a bankruptcy petition is filed and names the Department and impacts an interest of the Department, an actual reading of the meter must be obtained at or near the file date so that the Department can file an accurate claim for Utility Services. It is the Owner's responsibility to properly include the Department as a creditor in the Owner's bankruptcy filing. For the continuation of Utility Services after the bankruptcy file date, the Owner is treated like any new Customer and must apply for a contract for Utility Services and pay a deposit, i.e., the adequate assurances per Section 366 of the Bankruptcy Code. The deposit shall be determined by the Department. The Owner's failure to furnish access for an actual meter reading, or pay the required deposit when due, or to otherwise comply with these Rules and Regulations, may result in termination or refusal of Utility Services without further notice.

C. Receivership. Whenever a Customer is the principal in a receivership proceeding, an actual reading shall be obtained on the meter. The receiver shall furnish the Utilities Department



with a copy of his/her valid appointment papers from the court, highlighting the section that specifically states that the receiver is duly authorized to handle utility matters, in order to contract for service after the receiver's appointment date. Unless the Department was a named party to the receivership action with a resulting court order that validly binds the Department, for the continuation of Utility Services after the receivership appointment date, the receiver must contract for Utility Service in accordance with these Rules and Regulations and applicable law. The receiver may be required to sign an acknowledgment as to the exact amount of the Customer's arrearage and to make arrangements to pay the Customer's bill in full before any further Utility Service is granted. The receiver shall furnish a deposit to ensure payment for future Utility Services. The deposit shall be determined by the Department. The receiver's failure to furnish access for an actual reading or to pay the required deposit when due, or to otherwise comply with these Rules and Regulations may result in termination or refusal of service without further notice. The Department will only provide Utility Services to a Premises post-receivership once the receiver satisfies the Department's receivership requirements.

### **106.05 Additional Remedies**

Water loss, water theft, equipment tampering, equipment theft and similar investigations regarding Utility Services may be handled by any method determined by the Department and may include, without limitation, back billing for unbilled consumption or unauthorized use, the addition of charges to one or more accounts, the automatic forfeiture of any deposits, the filing of criminal charges and any other civil remedies permitted by law.

## **CHAPTER 107 TYPES OF ACCOUNTS**

### **107.01 Regular Accounts**

Regular accounts generally provide water and sanitary sewer services. They are continuous. Generally, all accounts (residential and commercial) are considered monthly. Any designation other than this shall be determined by the Department.

### **107.02 Sewer-Only Accounts**

Customers who do not use water provided by the Department but are connected to the sewage treatment system are sanitary sewer only accounts. Metering is by water meters or sewer meters.

A. The meters used for this service shall be purchased, maintained and tested by the Customer. The Department shall furnish and set the meter in a location determined by the Department at the Customers' expense. These meters must include a remote reading register or radio transmitter.

B. Sewer-only accounts are billed monthly.

C. Until such time as a meter is actually installed to measure water from the supplying structure, the Customer will be charged an estimated amount, determined by the size of the building, number of dwelling units and occupants.

D. Failure to comply with the requirement to install a meter within one (1) month after being duly notified of this requirement will result in billing at a rate no less than three (3) times the estimated average.

### **107.03 Hydrant Meter Accounts**

These accounts provide temporary use of water from fire hydrants for construction, demolition, agricultural, and similar purposes. Customers are required to pay deposits on meters and wrenches, to return them as required and to comply with all applicable laws and these Rules and Regulations. (See section 203.01)

### **107.04 Water-Only Accounts**

A. Customers who are not required to be connected to the sewage system are water-only accounts and are billed regularly for water consumption. Water-only accounts shall also include second accounts established for sprinkling purposes by Customers already served by a water/sewer account for domestic purposes. Such accounts may still be billed for other services.

B. Water-only accounts have replaced so-called "seasonal accounts." Customers shall be charged a minimum bill each billing period plus the volume charge for water consumed. When a water-only account is the second service for a structure, its meter shall be privately owned and must be connected in parallel with the first meter and located adjacent to it. The cost of the second meter, including any testing and/or repair charges, shall be paid by the Customer. Both meters must have remote-reading registers or radio transmitters. If the water-only service is used seasonally, winterizing it in the off-season shall be the responsibility of the Customer.

## **CHAPTER 200**

### **WATER SERVICES (TAPS AND SERVICE CONNECTION)**

#### **200.01 Payment For Tap And Tap Branch**

A. Advance payment of the charge for tap and tap branches one inch (1") and smaller shall be made by the property Owner. The schedule of tap and tap branch charges may be revised from time to time on the basis of the average costs, including overhead. Special conditions such as more than two-lane residential street crossings, downtown district, or conditions causing long or deep services may be performed on the basis of an estimate with a deposit of such estimated

charge.

B. Missed appointments for tap inspections may result in service charges being levied against the Customer's account. Further, tap inspections that can not be completed due to failure of Customer to provide access, no address on building, etc., or where conditions are not conducive to approval of the tap, such as services lacking locking ball valves, improperly stubbed lines, etc., may also result in service charges being accrued against Customer's account.

C. A tap fee, according to a schedule as determined by the Director, shall be paid before services larger than two inches (2") are installed. In addition, a plan review and inspection fee, according to a schedule determined by the Director, shall be paid prior to plans for services larger than two inches (2"), water main extensions, or fire lines are approved.

### **200.02 Installation Of Tap And Tap Branch**

All Tap installations may be done by the Department.

A. Domestic services (1") and smaller

1. The tap and tap branch (1") in size shall be installed only by the Water Distribution Department, unless specified by engineered plans call for contractor installation. No tap, new or replacement, smaller than three-quarter inch (3/4 ") shall be installed. In order for the tap to be made, the address of the property must be clearly displayed on the street side of the structure.

2. Multiple taps shall not be allowed on a single property and Splits between adjacent properties shall not be allowed.

3. Removal of the lock or seal, removal of the valve once locked, or any other incidents of noncompliance with the above regulation may result in a service charge for tampering with Water Distribution Department property. In addition, the Customer may be backbilled at three (3) times the minimum rate for the size service installed to the date the tap was made.

B. Domestic services one inches (1") and larger - Customer shall notify the Department at least three (3) days prior to starting construction to schedule inspection. Any underground work completed without being inspected or without the Department previously being notified, shall be subject to complete exposure or any checks which the Department may deem necessary before water is furnished through the service.

C. Taps (1") and smaller, on mains will be performed by Water Distribution; the tapping sleeve and valve shall be provided by the property Owner. Taps larger than (1") may be installed by Customer using a City approved contractor.

D. Commercial accounts having service to more than one structure may be permitted to

have a single tap based on approval from the Safety Service Director.

E. The Department reserves the right to impose, in addition to all other usage charges, an access charge to all properties with access to a main.

### **200.03 Taps - Service Size – Materials**

Water services shall be sized accordance with awwa standards.

A. Services one inch (1") and smaller shall be type "K" soft copper. No other type of material shall be used from the curb stop or control valve to, and including, the meter setting.

B. Water services larger than one inch (1") shall be type "K" soft copper or SDR 9 plastic, with tracer wire and 5' of copper stubbed out of meter setting for stability/rigidity. All fittings shall conform to AWWA standards/10 states standards. No other type of material shall be used from the public main to, and including, the meter setting.

### **200.04 Repairs To Tap and Water Service Line (City's side)**

A. Only the Water Distribution Department is permitted to make repairs to the tap or water service line up to the Curb stop/box. When lead services are discovered by the Distribution Operators, the entire water service shall be replaced, with new meter setting placed in the utility ROW. (This is to help lower unaccounted for water for the City as a whole).

B. Repairs to the tap and water service line one inch (1") and smaller in size from the main to the curbstop/box shall be assumed by Water Distribution. However, when the repairs are made necessary because of actions by or for the Owner of property, said Owner shall pay the full cost thereof. The City repairs leaks up to the curbstop/box. Leaks after the curbstop/box, including the meter setting, are the property owner's responsibility. If lead or iron lines are discovered on the customer's side, they must be replaced at the customer's expense before the service is reconnected.

C. Where the tap and water service line is damaged by a contractor or other utility, the full cost of repairs shall be borne by the party responsible for the damage.

D. The total cost of repairs of services larger than one inch in size shall be borne by the property Owner.

E. The Director shall require Owners of Split/Shared services to purchase a conventional tap in instances where this type of service becomes a source of problem and dispute. The cost and location of the tap shall be determined by the Safety Service Director based on the current location of the tap, split and meter pits. These taps will be replaced at cost to the involved Customers, but not to exceed the standard tap charge. Any repairs on the customer side of the

curbstop/box will be a joint responsibility of all the involved Customers. Any work done and costs involved will be determined by the Safety Service Director.

F. Where Water Distribution determines that it is more economical to replace than repair a substandard tap and tap branch (smaller than a three-Quarter inch (.750") in size), the Owner will be notified, if practical, and be required to have a standard tap and water service line installed in accordance with the schedule of charges for such work. The minimum standard tap size shall be one inch (1").

#### **200.05 Workmanship On Service Line (Customer's side)**

A. Installation work on Customer's water service line shall be in accordance with the American Water Works Association (AWWA) and these Rules and Regulations and ordinances of the City.

B. The Customer's Service line shall be Type K copper only. The pipe shall have a constant internal diameter from the tap through and including the curbstop. The pipe shall have a full waterway throughout, equal to the inside diameter of the pipe. Pipe ends shall be reamed to remove any obstruction to the flow of water. Where joints are needed, they shall be of the compression type only. Any exception requires the written approval from the Water Distribution Department.

C. The user shall allow inspection by the City of the piping system and meter installation during construction, and periodically thereafter, to ensure proper connections and usage.

#### **200.06 Depth Of Pipe**

All service pipe outside buildings, from the Main to the meter, shall have a minimum cover of 42" for all pipe. The cover shall be of a granular material.

#### **200.07 Customer's Water Service Line Location And Construction**

A. The Customer's Service line shall be installed in a direct line from the house to the street, and at right angles to the street. The Customer's Service line shall not be laid closer than ten feet (10') from a leach field/Septic system, sanitary sewer, storm sewer, nor closer than four feet(4') to any drain,gas line or other underground facility for the entire length of the Service line.

B. The Customer's Service line shall be so valved and/or controlled that after it is connected to the corporation stop, the curb stop valve could be left open. The Department will not be held responsible for any damages which occur due to improperly installed Customer Water Service line.

C. Mains will be tapped before building construction (pre-tapped) when, in the opinion of Water Distribution, savings in time and construction expenses or hazards will be the result. Procedures, rules and authority shall be established by Safety Service Director.

#### **200.08 Main Service Line Valves (Commercial)**

A. The main valve for the service at the outlet on the public Main shall be in a Valve box located in the Public ROW and constructed/installed by the City and/or a City approved contractor.

B. All secondary valves shall be at the option of the property Owner.

C. Secondary valves shall have adjustable valve boxes.

D. All domestic service extensions shall have a primary valve at the beginning of the service or the extension of the service.

#### **200.09 Customer's Service Line Leaks**

A. The water main to the curbbox/curbstop is the City's responsibility. Any Service Lines beyond the curb box including the Service Lateral are the customer's responsibility. When a leak on the Service line is discovered, the City will notify the Property Owner, the Customer or both by verbal communication, written notice or a door hanger at the premises. This notice will contain a directive to repair the leak with reasonable dispatch. If the leak occurs in the Service line where the meter is located inside (basement, crawl space, garage, etc) the Owner shall be required to relocate the meter and meter setting to within the City's utility right of way. This is required in order to reduce unaccounted for water losses due to leaks. If the Owner and/or Customer have not taken positive steps to repair the leak within five (5) days, the water service to the Premises may be turned off at the curb box.

B. Water service to the Premises shall not be restored until the ordered repairs have been completed. If deemed necessary by Water Distribution, on the basis of age and condition of the pipe, the entire Customer's Service Line shall be replaced with type "K" soft copper. If the leaking service is causing damage or a hazardous condition it may be turned off immediately, without prior notice.

#### **200.10 Defective Work**

Whenever the Department finds plumbing work that is defective, although not in direct violation of these Rules and Regulations, water will not be turned on until such defective work has been corrected.

### **CHAPTER 201**

## **METERS**

### **201.01 Services To Be Metered**

All Utility Services shall be metered unless specifically exempted by these Rules and Regulations and/or by ordinance.

### **201.02 Service Not Required To Be Metered**

Fire Service Lines four inches (4") and larger, when used only for furnishing water for fighting fires through private hydrants or a sprinkler system, are required to be metered. A meter size as specified by Water Distribution shall be installed at the Owner's expense at or near the property line in an approved enclosure whenever water has been used from a fire service pipeline for purposes other than for fire fighting.

### **201.03 Meters - Number Allowed**

- A. Not more than one (1) meter shall be used per property serviced by a single service.
- B. Any arrangements existing prior to 2011 that consist of an inside Split is subject to approval by the Director and may be allowed to remain provided, there are no disputes or leaks that would cause the meter to be relocated as mentioned in Section 200.09 (A).
- C. Conversion from single metering to multiple metering on existing Premises shall be considered a new service and an inside Split shall not be permitted.

### **201.04 Maintenance Of Service; Determination Of Meter Size; Installation Of Meters**

- A. The water service at all Premises shall be maintained in such physical condition that meters can be installed, exchanged, or tested as required. Any repairs necessary to maintain the service properly shall be the obligation of the Customer, including the full cost of any necessary plumbing repairs.
- B. A determination of the meter and service size required for a service shall follow American Water Works Standards (AWWA).

### **201.05 Meter Settings And Locations**

- A. For services up to and including two inches (2") - The valve on the inlet side shall be the locking type ball valve as specified in these Rules and Regulations. The valve on the outlet side shall be a check type valve to prevent backflow. The valves shall be the same diameter as the service pipe which, in the case of the smallest service, is required to be three-quarters of an inch (.750"). For meters that are smaller than one and one-half inches (1 1/2 "), tail-pieces and/or

bushings shall be installed at the inlet valve before the meter will be set. Only brass valves and bushings shall be used in the meter setting.

B. For services over two inches (2") - The valve on the inlet and outlet side shall be of the gate type; either resilient seat or double disc with non-rising stem, wheel handle and brass or cast-iron body, suitable for working pressures up to one hundred fifty (150) pounds. The valve shall be the same diameter as the service pipe. Dresser couplings shall be required on all settings of two inches (2") and larger before the meter will be installed.

C. Six (6) detailed sets of plans and specifications on all large underground domestic services shall be furnished to and approved by the Director before service will be granted. Design and construction shall be in conformance with the latest version of the AWWA standards approved by the Director. The plans shall include the profile of the service within the public right-of-way. Payment of the plans review and inspection fee shall be required prior to plan approval

D. Meters are required to be set with the register in a horizontal position at a point on the incoming service pipe as close as possible to the water main to reduce unaccounted for water. In buildings without basements, the meter shall be placed outside in an approved meter pit assembly. Approved prints are on file at the Department for both types of settings.

E. Such settings shall at all times have unobstructed access for the purpose of reading and servicing the meter. Under no condition shall a meter be placed under a sink, in a closet, a crawl space, or a secluded location.

F. A specially designed protected enclosure, removable by the Department without removing screws, bolts, or latches may be placed over a meter in an unprotected position.

G. The Department shall not be responsible for damage to floor coverings which are placed in such manner that it is necessary to walk over them to read or service a meter.

H. Meters may be placed in an attached garage, if heated; otherwise, meters must be placed in insulated enclosures of a design approved by Water Distribution to prevent freezing.

I. No one shall be permitted to install anything other than brass meter connections approved by Water Distribution.

J. Where a building is located more than one hundred fifty feet (150') from the property line, the meter shall be located in a vault or meter box. This box or vault shall be of a type similar and equal to Ford or Mueller meter boxes in use on small services. Plans for vaults or boxes for meter settings are on file at the office of Water Distribution and shall be constructed as shown. No obstruction shall be placed at any time on the cover of such vaults or boxes, and the covers shall be kept free from snow and ice. The vault cover shall be as specified on Water



Distribution print. These vaults shall be maintained in a manner so that the meter may be read and serviced by Water Distribution. A drawing of a typical vault setting is attached to these rules and regulations.

K. A drain with sufficient capacity to carry off all water that can leak from a meter or meter setting, or seep into the vault due to a high water table, is required to be installed in such a manner that damage to the property and/or furnishings from such leaks is prevented. The Department is not responsible for damage caused by water leaking from a meter or meter setting.

L. Water service will not be provided to Premises until the requirements of this section are complied with, regardless of the extent of corrective alterations needed.

#### **201.06 Removal Of Meters**

Residential Meters shall be removed only by the Department except as otherwise provided for in these Rules and Regulations. Violation of this regulation may result in a charge being added to the Customer's account for expenses incurred, in addition to charges for damage to or loss of meters, and charges for the amount of un-metered water estimated to have been used.

#### **201.07 Accuracy Of Meters**

Meters used by the Department, whether owned by the Department or by the Customer, shall meet the accuracy specifications of the AWWA as modified by the Department. This shall apply both to new and to repaired meters.

#### **201.08 Damaged And Worn Meters**

A. If the need for repairs to or replacement of meters owned by the City is caused by, without limitation, freezing, hot water, neglect or malicious damage, a charge based on average costs will be made for the repair or replacement of the meter.

B. The cost of repairs to five-eighths inch (5/8"), three-fourths inch (3/4"), and one-inch (1") meters, owned by the City, made necessary because of normal wear and deterioration will be assumed by the City.

#### **201.09 Testing And Repair Of Commercial Meters**

A. Commercial water or sewer meters shall be tested regularly at intervals as determined by the Director, but such intervals may not be more stringent than those proposed by the AWWA. Two-inch (2") water meters shall be tested every five (5) years. Meters over two inches (2") in diameter shall be tested every three (3) years. Such tests shall be conducted by a qualified meter testing company which is certified by the Department, and at the expense of the Customer. Written certified test results shall be provided to the Department within thirty (30) days of the

test.

B. Commercial meters over 1” are solely the property owner’s responsibility. The City may require property owners to upgrade the meter to new technology for the purpose of reading/testing of the meter. The owner will be notified by mail that this should be rectified within 120 days to avoid disconnection of service.

C. In addition, if the Director has reason to believe that a private water or sewer meter used for billing purposes is sufficiently in error, a certified meter test may be required at the expense of the Customer. This test shall be completed and the results certified to the Department within sixty (60) days of notification.

D. If such test produces evidence that said meter does not meet AWWA accuracy standards, the Customer shall have thirty (30) days from the date of notification of meter malfunction to effect repairs. Failure to comply within this period may result in termination of service. Repair of commercial meters shall be the responsibility of, and at the expense of, the Customer.

E. Failure to comply within sixty (60) days with the required certified testing after being notified of this requirement may result in termination of service. To have Utility Service reinstated, the Customer will be required to provide a certified test result of meter accuracy, and a turn-on fee established by the Director will be charged.

F. The Department reserves the right to require periodic testing and/or replacement of meters measuring water pumped from private wells as well as the annual testing of sewer meters.

#### **201.10 Testing And Repair Of Department-Owned Meters**

A. Meters owned by the Department may be tested at the request of the Department or of the Customer. If a Customer asserts a good faith claim that a Department-Owned meter is inaccurate, the Customer may have the meter tested as provided in these Rules and Regulations. Customer requests shall be in writing and shall be accompanied by an authorization to debit the Customer's account according to the schedule of fees and charges (See Appendix B), if required.

B. It is in the best interests of the Customer to be present to witness the test. If the Customer chooses not to witness the test, the findings of departmental personnel conducting the test shall be accepted as final.

C. If, upon testing, the meter is found to be accurate in accordance with AWWA standards, no adjustment will be made to the previous billing, and the Customer will be charged for the meter test according to the schedule of fees and charges (See Appendix B). If the meter is found to be inaccurate in accordance with AWWA standards, the bill will be adjusted as deemed appropriate in light of the evidence and no testing charge will be made.

D. If a meter fails to register or is found to be out of order, a Customer shall be charged based on an estimate of the average consumption using historical and comparable data. The meter shall then be replaced with a working meter. The City will provide the meter if the size is 1" or under, however the cost of any updates or repairs will be the responsibility of the customer, including but not limited to updating/replacing the meter pit. Failure to comply within thirty (30) days may result in termination of service.

E. If a remote register or radio transmitter fails slowly or ceases working altogether, a Customer will be charged according to the consumption registered by the meter.

### **201.11 Tampering With Meter or Related Appurtenances**

A. Tampering with the meter, remote register, radio transmitter, or any related appurtenances equipment or systems is strictly prohibited. If the Department finds that a meter seal has been broken or there is evidence that a meter has been tampered with, the water service to the premises shall be shut off without notice, and the owner shall be assessed a fee for meter tampering. Repeat violation of meter tampering will result in prosecutions to the extent provided by law. ORC 4933.22

B. Before the water is restored, the Customer shall also pay for the estimated quantity of water and/or sewer use as calculated by the Department which has not been registered because of said tampering. Repeated violations may result in termination of water service and/or administrative remedies and/or legal remedies as provided by law.

### **201.12 By-Passes On Meter Settings**

By-passes around meter settings shall be required for two-inch (2") and larger meter installations not used for fire prevention. By-passes shall not be permitted on meter installations less than two inches (2"). Such by-pass installations shall be in accordance with the Water Distribution specifications. By-pass valves shall be sealed by the Department or its authorized agents. In the event that meter settings are downsized to less than a two-inch (2") meter size, the by-pass shall be removed and capped by the Customer.

### **201.13 Touch Pad and Radio Transmitter**

A. Touch Pad or radio transmitters shall be required on all meters installed on services supplying buildings for which a building permit has been issued.

B. Waiver of the touch pad installation requirement will occur only when conditions exist so that it is not feasible to make the installation, as determined by the Safety Service Director. At this point a radio transmitter shall be installed.

C. All new construction shall have radio transmitters installed.

D. Touch Pad and radio transmitters may not be installed to relieve the Owner of the responsibility of placing the meter in a pit where required by regulations.

E. Touch Pad and radio transmitters shall be installed only by Water Distribution Department. The Department shall not be responsible for the defacement or damage of property caused by necessary holes, fastenings or other work required for proper installation.

F. If a touch pad or radio transmitter fails to record properly, or is found to be out of order, the Customer shall be charged according to the reading of the meter. When a read is made due to a change of Customers on an account where there is a remote register or radio transmitter, the reading shall include both the so-called inside and the outside meters. If the two readings do not agree, the so-called inside meter shall prevail. In such a case, the Water Department shall investigate and correct the reason for the discrepancy and realign the inside and outside meters.

#### **201.14 Charges - Remote Registers and Radio Transmitters**

A. The Director shall establish charges covering the installation of remote reading registers and radio transmitters. Registers, transmitters, fastenings, and connections shall remain the property of Water Distribution and may not be removed from one setting to another.

B. In newly constructed buildings or buildings receiving water service (less than 2" size) for the first time, Water Distribution will install one (1) radio transmitter without cost to the Customer. To have additional radio transmitters installed, the standard charge will be assessed for each additional transmitter.

C. Water Distribution will maintain radio transmitters under the same provisions as meters are maintained. The standard posted charge for replacement to any remote register or radio transmitter or connections necessitated by damage or neglect by the Customer shall be made in addition to any charge provided for by these Rules and Regulations.

D. Water Distribution will remove a meter and remote register and test and install a remote register and meter and/or radio transmitter, as the case may be, when requested by a Customer to do so. The standard charge, in addition to any charge provided for by these Rules and Regulations, will be assessed for this service.

#### **201.15 Metering Methods (including Alternate Metering)**

The methods available for metering are:

A. Standard Metering - A water meter on the water Service Line for measuring all water supplied to the user with the sewer service charge being applied to one hundred percent (100%)

of the water usage.

B. A "Commercial Sewer Deduct Meter" measures water that does not go to a sanitary sewer but is added to a product, evaporates into the atmosphere, is removed from the business site, is used for outside watering, etc. This volume of water is deducted from the main water/sewer meter volume to determine the actual volume received by the sanitary sewer. A meter used for this purpose must be purchased and installed by the property owner. Once the meter has been installed, an inspection by the water department will be made to assure the meter has been installed properly. A one-time non-transferrable, non-refundable inspection fee of \$100.00 will be assessed. If the use or location of the meter changes there will be an additional inspection fee of \$100.00. The meter will be read monthly at the same time the master meter is read. This meter must be a radio read compatible meter. The property owner assumes all responsibility for the accuracy of the meter and will not be issued a credit for an inaccurate meter.

C. "Residential Auxiliary Sewer Deduct Meter" A seasonal program that runs from, the date the customer brings in the meter for a reading (no earlier than March 1<sup>st</sup>) to October 31<sup>st</sup> of each year intended for residential outside water usage only that does not discharge into the sanitary sewer system.

1. A deduct meter reading in cubic feet used for this program shall be purchased by the customer from an approved source. If quantities permit, the customer may pick up a sewer deduct meter from the Water Department. A City owned meter is to be returned when the program is terminated by customer or by the Department. The Department will not be responsible for accuracy or maintenance of Sewer Deduct Meters.
2. To join the program the customer will be billed a one-time non-refundable, non-transferable fee of \$25.00 for each sewer deduct meter. The customer must bring the sewer deduct meter in before usage, no earlier than March 1<sup>st</sup> for the Water Department to record the reading. The meter must be brought back to the water office on or before October 31<sup>st</sup> of each year for the Water Department to record the reading in order to receive a credit on the customers December billing statement. The total usage will be calculated based on the March and October readings and a credit to the sewer portion of the bill will be given for this usage.
3. New Customers joining the program will be required to hook up the sewer deduct meter outside. No plumbed-in meters will be allowed. Any meters that were plumbed in prior to 2011 are permitted to remain as long as a discrepancy or dispute does not arise in which case the customer will be required to move the meter outside. The City will create a work order to read the designated meters in March and again by October 31<sup>st</sup> to obtain the readings and give credit for the usage.
4. The City reserves the right to terminate any Customer from the program without

notification for reasons including but not limited to: suspicion of abuse or illegal use of the program or meter.

### **201.16 Inquiries**

Questions pertaining to sewage metering should be directed to the Division of Waste Water Treatment. Questions pertaining to water metering shall be directed to Water Distribution.

## **CHAPTER 202 FIRE PROTECTION SERVICES**

### **202.01 Application For Fire Protection System Service**

Application for a fire protection Service Connection to the water distribution system shall be made at the office of the Director in accordance with these Rules and Regulations. All information called for on the form shall be furnished, including number of private hydrants on the system, if any.

### **202.02 New Fire Systems and Modifications To Existing Fire Systems**

A. Six (6) detailed sets of plans and specifications on all underground fire protection systems in the City corporate limits or service territory shall be furnished to and approved by the Director. Within the City corporate limits, plans must also be approved by the Chief of the Fire Department before service will be granted. Outside the City corporate limits, plans must also be approved by the political subdivision that owns the distribution system and the governing fire authority, unless otherwise indicated by the Director. Design and construction shall be in conformance with the latest version of the City's "Infrastructure Design and Construction Requirements." The plans shall include the profile of the fire service within the public right-of-way. Payment of the plans review and inspection fee shall be required prior to plan approval in accordance with these Rules and Regulations. The depth of fire services shall be as specified in these Rules and Regulations. Fire protection systems shall be constructed of materials as specified in these Rules and Regulations.

B. Taps for fire protection services shall be in accordance with these Rules and Regulations.

C. When requested by the Division of Water Distribution or the Director, plans and specifications shall be furnished for existing fire protection systems within thirty (30) days after notice to do so.

D. For all fire services in the City, hydrants shall be as specified by the Director and shall

have standard City outlets or those required by the NFPA and pumper nozzles shall have integral Storz connector. All hydrants shall have branch valves or comply with the requirements of the NFPA. Location of hydrants shall be as recommended by the appropriate fire department.

### **202.03 Changes In Fire Protection System**

A. No changes, alterations or extensions of any fire protection system shall be made without first securing approval from the Director, the political subdivision that owns the distribution system, and the Fire Department or governing fire authority. Application for same shall be made in writing prior to starting work.

B. Six (6) detailed sets of plans and specifications on all underground fire protection systems shall be furnished to and approved by the Director. Within the City corporate limits, plans must also be approved by the Fire Department before service will be granted. Outside the City corporate limits, plans must also be approved by the political subdivision that owns the distribution system and the governing fire authority, unless otherwise indicated by the Director. Payment of the plans review and inspection fee shall be required prior to plan approval, in accordance with these Rules and Regulations. When requested, plans and specifications shall be furnished for fire protection systems that are now in use within thirty (30) days after notice to do so. The plans shall include the profile and a bill of materials, if so required.

C. Fire protection systems shall be constructed of materials as specified in these Rules and Regulations.

### **202.04 Fees For Tapping, Plan Review And Inspection**

Tap fees and plan review and inspection fees for fire protection services shall be paid in accordance with these Rules and Regulations.

### **202.05 Consumption Of Water From A Fire System**

A. Pipelines intended for fire protection shall not be tapped or used for the general supply of any building, structure or Premises, unless specifically authorized by the Director and not until a meter has been installed in accordance with these Rules and Regulations and/or as directed by the Department.

B. Any unauthorized taps or use of fire protection service shall be deemed a violation of these rules and regulations.

### **202.06 Water Supplies And Pressure**

The Department will not be responsible for the furnishing and maintaining of any set amount of water at a given pressure or for the lack of Utility Service on a limited fire service.

### **202.07 Violations**

If at any time a fire protection system is found to be in violation of any City ordinances or these Rules and Regulations, all changes necessary to bring the systems into compliance shall be made within thirty (30) days after notice to do so. A copy of the notice may be sent to the interested insurance company, if known. Failure to comply as directed may result in discontinuance of Utility Service.

### **202.08 Drip Or Blow-Off Valves**

The use of drip or blow-off valves for draining fire services shall be allowed only in cases of absolute necessity, as determined by the Department, and in no case shall their installation be permitted unless furnished with a valve, which shall be approved and sealed by Water Distribution, and the end of every such pipe shall be exposed to view at all times. The size of drip or blow-off pipes shall be as approved by Water Distribution in each case.

### **202.09 Pipes, Etc., To Be Accessible For Inspection**

A. Fire pipes, valves and other accessories which are part of the fire protection system shall be so installed as to be accessible for purposes of inspection at all times, unless exposed to the weather, in which case minimum earth cover of sixty inches (60") or equivalent, shall be maintained.

B. The contractor performing work in the City, on new or existing fire systems, shall be licensed by the State of Ohio Fire Marshal. Contractors working outside the City shall be licensed by the State of Ohio Fire Marshal and are subject to the requirements of the governing fire authority. The Owner shall submit to the Director for approval the name of the contractor(s) employed to install the system. Once approval is granted, the Owner or the Owner's contractor(s) shall notify the Division at least three (3) days in advance of any work on the system so an inspector may be assigned to the job on all underground installation. Charges for the inspection shall be paid in advance as required in Chapter 200 of these Rules and Regulations.

C. Termination of underground construction of the fire service will be at the first joint above the floor line. The Customer will be responsible for construction to this joint. The Division of Water Distribution will have jurisdiction of the inside internal fire system, from the connection of the City main to the wall valve. The jurisdiction may extend beyond these limits where underground systems extend off the internal fire systems when not metered.

D. Any underground work completed without being inspected by Water Distribution or the



Director, may be subject to complete exposure or any other inspection, which the Department may deem necessary before water is furnished through the service.

### **202.10 Fire Pumps**

All fire protection systems with fire pump installations shall be reviewed by Water Distribution and the Chief of the Fire Department and are subject to these Rules and Regulations.

### **202.11 Check Valves**

A. All automatic fire protection systems shall have check valves as required by the NFPA.

B. Fire systems having a looped system with more than one source of supply from the City distribution system shall provide a check valve at each source. The check valve shall be located on private property and within ten feet (10') of the public right-of-way or as specified by Director. Double check valves may be required, in lieu of single check valves, at each source to protect against pollution hazards, as determine by Water Distribution.

C. A standard Water Distribution manhole shall be constructed over each check valve.

### **202.12 Cross-Connection Control**

A. For Cross-Connection control, fire protection systems may be classified on the basis of water source and arrangement of supplies as follows:

1. Class 1 - Direct connections from public water mains only; no pumps, tanks or reservoirs; no physical connection from other water supplies; no antifreeze or other additives of any kind; all sprinkler drains discharging to atmosphere, dry wells, or other safe outlets.

2. Class 2 - Same as Class 1, except that booster pumps may be installed in the connections from the street mains. (Booster pumps do not affect the potability of the system, but it is necessary to avoid drafting so much water that pressure in the water main is reduced below Thirty five PSI (35psi).

3. Class 3 - Direct connection from public water supply main plus one or more of the following: elevated storage tanks; fire pumps taking suction from above-ground covered reservoirs or tanks; and pressure tanks. (All storage facilities are filled or connected to public water only, the water in the tanks to be maintained in a potable condition. Otherwise, Class 3 systems are the same as Class 1.)

4. Class 4 - Directly supplied from public mains similar to Classes 1 and 2, and with an auxiliary water supply on or available to the Premises; or an auxiliary supply may be located within seventeen hundred feet (1,700') of the pumper connection.

5. Class 5 - Directly supplied from public mains, and interconnected with auxiliary supplies, such as: pumps taking suction from reservoirs exposed to Contamination, or rivers and

ponds; driven wells; mills or other industrial water systems; or where antifreeze or other additives are used.

6. Class 6 - Combined industrial and fire protection systems supplied from the public water mains only, with or without gravity storage or pump suction tanks.

B. Class 1, 2 and 3 fire protection systems will normally require minimum protection (approved double-check valves) to prevent stagnant waters from back-flowing into the public potable water system. Class 4 systems will normally require Backflow prevention at the Service Connection. The type (air gap, reduced-pressure, or double check valves) will generally depend on the quality of the auxiliary supply. Classes 4 and 5 systems normally need maximum protection (air gap or reduced pressure) to protect the public potable water system. Class 6 system protection depends on the requirements of both industry and fire protection, and can only be determined by a survey of the Premises.

C. A meter (compound, detector check) is not normally permitted as part of a Backflow Prevention Device. Exceptions may be made if the meters and Backflow Prevention Devices are specifically designed for that purpose.

D. All "Anti-Freeze" fire protection systems shall have a "Reduced Pressure Principal Backflow Prevention Device" in the system. The manufacturer shall be as approved by the OEPA.

### **202.13 Miscellaneous Appurtenances or Extensions**

A. The property Owner shall install any miscellaneous appurtenances as required by the Director and the Chief of the Fire Department.

B. Domestic Services Off of Fire Services - any domestic Utility Service that is extended off of a fire service system shall be subject to Chapter 200 of these Rules and Regulations.

### **202.14 Maintenance Or Repair**

Maintenance or repair of the fire protection system shall be the total responsibility of the Owner from the water main in the street to the terminus of the system, including tapping sleeve, valves, valve boxes and all related items. Maintenance or repair work may be performed by Water Distribution personnel provided the Owner submits an authorization form or letter of authorization for this work to the Division and agrees to pay all costs. The Water Distribution cannot repair systems that have an internal fire protection system.

### **202.15 Test Of Private Fire Protection System**

Before water service will be furnished to a private fire protection system, a pressure test satisfactory to the Department shall be made by the contractor and witnessed by a representative of the Department. This test shall include all underground piping from the tapping valve to the

building being serviced. After a satisfactory pressure test has been completed, a bacteriological test shall be made by the Department, and the system shall meet all drinking water standards prior to any water being supplied through this service.

The installing contractor shall provide to the Department a completed "Contractor's Material and Test Certificate for Underground Piping." The certificate shall be signed by the Owner and the licensed, certified contractor identified in Chapter 202 of these Rules and Regulations.

#### **202.16 Tests By Insurance Company Representatives**

Private fire systems and all connected apparatus may be tested by parties owning the same or by the insurance inspectors. Written notice shall be given to Water Distribution that such a test is desired one (1) week prior to the date of the test. The Division may have an employee present if it so desires.

#### **202.17 Fire Flow Tests By Insurance Company Representatives**

Fire flow tests on any hydrants may be conducted by insurance companies under the following conditions:

A. Written notice shall be given to the Division of Water Distribution that the test is desired one (1) week prior to the date of the test.

B. All tests shall be made in the presence of a representative of the Division of Water Distribution. A charge shall be made for the employee's time based on costs as determined by the Division.

C. The insurance companies requesting such tests shall provide sufficient personnel to conduct these tests.

#### **202.18 Damage Due To Water Turn Off**

The Department disclaims any responsibility for damages that may occur due to lack of fire protection service when said service was terminated for any reasons.

#### **202.19 Annual Report Required**

Commercial and industrial account holders that are required to install and test a Backflow Prevention Device shall complete a backflow prevention review form at least once every twelve months as determined by the Department.

### **CHAPTER 203**

## **PUBLIC HYDRANTS**

### **203.01 Use Of Public Hydrants By Other Than Authorized Governmental Agencies**

A. No Person shall obtain or use water from a hydrant except with the permission of the Director. An application for a permit to obtain water from a hydrant shall be made at the Port Clinton Water Department. Use of the hydrant shall be subject to the conditions contained in the permit and, in the event it is determined that use of the water from the hydrant is not in the best interest of the water distribution system, the permit may be canceled and any excess deposit will be returned.

B. An RPZ backflow device, provided by the Department, shall be used on all hydrant meters. Hydrants used shall be pumped and/or thawed out by the permit holder, using methods approved by the Department. If this is not satisfactorily completed daily, the permit may be revoked and any work required of the Department may be paid from the deposit on file.

C. A deposit (See Appendix B - Fees & Charges) shall be collected from the applicant before a permit will be issued by the Department. The amount of the deposit shall be established by the Director and shall be used to recover unpaid charges, the cost of missing or damaged wrenches, hose connections, meters and hydrants. The deposit shall be refunded upon the payment of all outstanding charges and the return in good condition of all the equipment provided by the Department.

1. The permit holder shall not draw water from a hydrant except with an authorized wrench and meter supplied by the Department. The use of non-Department connections may be authorized upon written request to the Water Department stating the justification for such use. All unauthorized connections, wrenches, hoses, meters or any other devices attached to any hydrant may be confiscated by the Department. Any evidence of tampering with the meter, unauthorized usage or theft of Utility Service may result in the immediate termination of the permit and other enforcement actions permitted by these Rules and Regulations. A copy of the application authorizing the use of the hydrant shall be kept at the site while water is being used and shall be made available for inspection by the City.

2. The Director shall establish the amount to be charged for the deposit (See Appendix B - Fees & Charges), minimum water use fee, and metered water usage fee. The minimum water use fee and/or metered or estimated water usage fee and the cost of any necessary repairs shall be paid by the permit holder. Payment shall be made in accordance with these Rules and Regulations.

3. Any Person seeking to use a hydrant outside the City's corporate limits but within City's service territory shall first obtain a permit from the governmental entity in whose jurisdiction the hydrant is located. This permit shall be presented at the time an application is made for a permit from the Department. Individual permits and meters shall be required for each

jurisdiction in which the meter is used.

4. No Person shall install a water Service Connection to any hydrant where a booster pump has been installed on the Service Line to such hydrant, unless such booster pump is equipped with a minimum pressure sustaining valve (psv) set to close should the supply pressure drop below 10 psi. Booster pumps installed prior to the effective date of OAC ' 3745-95-07 may, in lieu of a psv, use a low pressure cut-off designed to shut off the booster pump when the pressure in the Service Line on the suction side of the pump drops to ten pounds per square inch (10 psi) gauge or less. All pumping equipment must be approved by the Water Department before installation.

5. Hydrants shall be opened a minimum of seven (7) complete turns on the operating nut. The hydrant must be opened and closed slowly to prevent water hammer from developing within the main. If less water is required than supplied by the hydrant in its open position, an external valve furnished by the permit holder shall be inserted in the line beyond the hose adapter furnished by the Department to regulate the flow. Hydrants shall be left in a condition equal to or better than that found; i.e., all caps replaced on the nozzles and tightened securely with the wrench. The permit holder shall be responsible for cost of repairs necessitated due to damage to hydrants caused by authorized or unauthorized use.

6. Violation of any provision of this section shall constitute a violation of City Code. The holder of a permit shall hold the City harmless from any cost, claim or action resulting from the use of a hydrant.

### **203.02 Use Of Public Hydrants By Authorized Governmental Agencies**

A. Authorized governmental agencies, except fire units, shall use only those hydrants and hydrant connections approved by the Department.

B. Only approved hydrant wrenches are to be used to operate hydrants. Fire Department operations and sewer cleaning operations shall be coordinated with the Safety Service Director to minimize rusty water complaints as much as possible. The cost to correct any and all damages, including those caused by rusty water, shall be the responsibility of the agency using the hydrant.

C. Governmental agencies may be billed by the Department for water consumed while using a hydrant. Consumption will be estimated and bills calculated at rates prevailing for all like Customers of the water distribution system.

### **203.03 Flow Tests on Public Hydrants**

Requests for flow tests on public hydrants shall be submitted in writing to the Water Department. The request shall include the location of the test and the flow test fee. Flow tests will be performed by the Water Department as time and weather permit. Flow test results are

kept on file at the Water Department and are typically considered valid for three years from the date of the test.

## **CHAPTER 204 CROSS CONNECTIONS**

### **204.01 Cross-Connection Control & General Policy**

A. The general policy of the Department is:

1. To protect the public Potable Water supply from Contamination or pollution by isolating within the Consumer Water System contaminants or pollutants which could Backflow through the Service Connection into the public potable water system.

2. To promote the elimination or control of existing Cross-Connection, actual or potential, between the public or Consumer's potable water system and non-potable water systems, plumbing fixtures and sources or systems containing Process Fluids.

3. To provide for the maintenance of a continuing program of Cross-Connection control which will systematically and effectively prevent the Contamination or pollution of the public and Consumer's potable water system.

B. Application. These Rules and Regulations shall apply to all Premises served by the City's public potable water system.

C. Policy. The Water Purveyor shall be responsible for the protection of the public water supply system from Contamination due to back-pressure or back-siphonage of contaminants through the Customer's water Service Connection. If, in the judgment of the Water Purveyor, an approved Backflow Prevention Device is necessary for the safety of the public water supply system, the Water Purveyor will give notice to the Consumer for installation of such approved Backflow Prevention Device at each Service Connection to the Premises. The water Consumer shall immediately install such approved assembly or method at his own expense. Failure, refusal or inability on the part of the Consumer to install such assembly or assemblies immediately shall constitute grounds for discontinuing water service to the Premises until such assembly or assemblies have been installed and tested per this regulation.

D. The use of the approved Backflow Prevention Device at the water Service Connection does not affect or eliminate the need for individual fixture devices or air-gaps, as required by Ohio Plumbing Code.

### **204.02 Water System**

A. The water system shall be considered as made up of two parts; the public potable water

system and the Consumer Water System.

B. The public potable water system shall consist of the source facilities and the distribution system, and shall include all those facilities of the potable water system under the control of the Water Purveyor up to the point where the Consumer Water System begins.

C. The source shall include all components of the facilities used in the production, treatment, storage and delivery of water to the public distribution system.

D. The public distribution system shall include the network of conduits used for delivery of water from the source to the Consumer Water System.

E. The Consumer Water System shall include those parts of the facilities beyond the Service Connection (curb box) which are used in conveying water from the public distribution system to points of use.

### **204.03 Cross-Connections Prohibited**

A. No water Service Connection shall be installed or maintained to any Premises where actual or potential Cross-Connections to the public potable or Consumer Water System may exist unless such actual or potential Cross-Connections are abated or controlled to the satisfaction of the Water Purveyor.

B. No connection shall be installed or maintained whereby water from an Auxiliary Water System may enter a public potable or Consumer Water System unless such Auxiliary Water System shall have been approved by the Water Purveyor and by the Director of OEPA as required by ORC ' 6109.13.

C. There shall be no arrangement or connection by which an unsafe substance may enter the public water supply.

D. A Consumer with an Auxiliary Water System shall, at its sole expense, have the Auxiliary Water System inspected and tested by a State of Ohio, Department of Health, Certified Backflow Tester, who must also be registered with the Division of Water Distribution, at least once every twelve months as determined by the Department. The Department may charge a registration fee.

E. In the event an Auxiliary Water System is discontinued, the Consumer shall at Customer's sole expense and without limitation:

1. Cap your well in accordance with applicable laws, rules and regulations.
2. Remove all electrical wiring, piping, and the pump from the well.

3. Cut and plug the supply line prior to entering the structure.
4. Have the disassembled system inspected and submit the results to the Division of Water Distribution.

#### **204.04 Survey And Investigations**

A. The Consumer's Premises shall be open at all reasonable times to the Water Purveyor, for the conduction of surveys and investigations of water use practices within the Consumer's Premises.

B. On request by the Water Purveyor, the Consumer shall furnish information regarding the piping system or water use within the Consumer's Premises. The Consumer's Premise shall be open at all reasonable times to the Water Purveyor for the verification of information submitted.

C. Paragraph (A) of this section does not relieve the Consumer of the responsibility for conducting, or causing to be conducted, periodic surveys of water use practices on his Premises to determine whether there are actual or potential Cross-Connections in the Consumer Water System through which contaminants or pollutants could Backflow into the Consumer's or the public potable water system.

D. It is the responsibility of the Consumer to prevent Backflow in the public water system by ensuring that:

1. All Cross-Connections shall be approved, removed or protected to the satisfaction of the Water Purveyor; and
2. Backflow Prevention Devices shall be installed and maintained in accordance with these Rules and Regulations.

#### **204.05 Where Protection Is Required**

A. An Approved Backflow Prevention Device shall be installed on each Service Line to a Consumer Water System serving his Premises where, in the judgment of the Water Purveyor, actual or potential hazards to the public potable water system exist.

B. An Approved Backflow Prevention Device or method shall be installed on each Service Line to a Consumer Water System serving properties where any of the following conditions exist:

1. Properties having, or having had, access to a second source of water;



2. Premises on which any substance is handled in such a fashion as to create an actual or potential hazard to the public potable water system. This shall include Premises having sources or systems containing Process Fluids or waters originating from the public potable water system, which are no longer under the sanitary control of the Water Purveyor;

3. Premises having internal Cross-Connections that, in the judgment of the Water Purveyor, are not correctable; or intricate plumbing arrangements which make it impractical to determine whether or not Cross-Connections exist;

4. Premises where, because of security requirements or other prohibitions or restrictions, it is impossible or impractical to make a complete Cross-Connection survey;

5. Premises having a repeated history of Cross-Connections being established or reestablished;

6. Others specified by the Director.

#### **204.06 Type Of Hazards – Ohio Environmental Protection Agency**

- A. Severe Health Hazard
- B. Health Hazard
- C. System Hazard
- D. Pollution Hazard

#### **204.07 Backflow Prevention Devices**

An Approved Backflow Prevention Device of the type designated shall be installed on all commercial water Service Connection to the following types of facilities unless the Water Purveyor determines that no real or potential health, pollution, or System Hazard to the public water system exists.

All commercial businesses must have an ASSE 1013 or better installed.

All Backflow Prevention Devices shall include properly located test cocks and manufacturer approved tightly closing shut-off valves. The requirements of OAC 3745-95-06(A).

## BACKFLOW PREVENTION APPLICATION CHART

	DEVICE	ASSE NO.	HAZARD LEVEL	PROTECTION PROVIDED
<b>1</b>	Air Gap Separation	ANSI A112.1	Severe High, High or Low Hazard	Backsiphonage / Backpressure
<b>2</b>	Pipe Applied Atmospheric Vacuum Breaker	ASSE 1001 W-4"	High or Low Hazard	Backsiphonage Only No continuous pressure
<b>3</b>	Water Closet Ballcock Anti-Siphon Type	ASSE 1002	High or Low Hazard	Backsiphonage Only
<b>4</b>	Hose Connection Vacuum Breaker	ASSE 1011 1/2", 3/4", 1"	High or Low Hazard	Backsiphonage Low Head Backpressure No continuous pressure
<b>5</b>	Backflow Preventer with Intermediate Atmospheric Vent	ASSE 1012 1/4", 3/4"	Low Hazard Low Pressure	Backsiphonage / Backpressure
<b>6</b>	Reduced Pressure Principle Backflow Preventer	ASSE 1013 3/8"- 10"	High or Low Hazard	Backsiphonage / Backpressure
<b>7</b>	Reduced Pressure Principle Detector Check Assembly	ASSE 1047 1 1/2"-10"	High or Low Hazard fire sprinkler systems	Backsiphonage / Backpressure
<b>8</b>	Double Check Valve Assembly	ASSE 1015 3/8"-10"	Low Hazard Only	Backsiphonage / Backpressure
<b>9</b>	Double Check Detector Check Assembly	ASSE 1048 1 1/2" - 10"	Low Hazard Only fire sprinkler systems	Backsiphonage / Backpressure
<b>10</b>	FrostProof Wall Hydrant, Automatic Draining	ASSE 1019 3/4" & 1"	High or Low Hazard	Backsiphonage Low Head Backpressure No continuous pressure
<b>11</b>	Pressure Vacuum Breaker	ASSE 1020 1/2" - 2"	High or Low Hazard	Backsiphonage Only

12	Backflow Preventer for Carbonated Beverage Dispenser	ASSE 1022 y4” - 3/8”	High or Low Hazard	Backsiphonage / Backpressure
13	Dual Check Valve Type Backflow Preventer	ASSE 1024 Sizes */4”-1”	Low Hazard Only	Backsiphonage / Backpressure
14	Dual Check Valve Type Backflow Preventer for Post- Mix Beverage Dispenser	ASSE 1032 !A” - 3/8”	Low Hazard Only	Backsiphonage / Backpressure
15	Laboratory Faucet Vacuum Breaker	ASSE 1035 3/8”	High or Low Hazard	Backsiphonage Low Head Backpressure No continuous pressure
16	Hose Connection Vacuum Breaker	ASSE 1052 •/2”-1”	High or Low Hazard	Backsiphonage Low Head Backpressure
17	Backsiphonage Vacuum Breaker, Spill-Proof	ASSE 1056 1/8”-2”	High or Low Hazard	Backsiphonage Only

## BACKFLOW PREVENTION APPLICATION CHART

INSTALLATION		EXAMPLES OF INSTALLATION
1	Should be used whenever possible, is the only absolute means of preventing backflow	Lavatories, process tanks, sinks, bathtubs, and cooling towers
2	May not have a downstream valve since this device is not designed to operate under continuous pressure	Irrigation systems, process tanks, dishwashers, and soap dispensers
3	Tank type water closet or flush tank for urinals	Water closet or flush type urinals
4	Low head backpressure is intended to mean negligible backpressure in the 1.0 psi to 4.0 psi range, no continuous pressure over 12 hrs	Hose bib connections
5	Low hazard cross-connections under continuous pressure, but may not be subject to backpressure	Residential boilers or cooling towers containing no additives
6	Cross-connections subject to backsiphonage or backpressure and operating under continuous pressure	Main supply lines, commercial or chemically treated boilers or chillers, main hospital lines and equipment, tanks with submerged inlets
7	Installed on a fire protection system containing any additive, even a food-grade additive	Chemically charged fire protection systems (such as Foamite), or a fire protection system that contains any additive or anti-freeze
8	Installed to prevent the backflow of a substance that would not present a hazard to health	Main supply lines, food cookers, tanks or vats containing non-toxic substances
9	Installed on a fire protection system that contains only the public water, has no booster pump, storage, or auxiliary water	Non-chemically charged and/or non-toxic fire protection systems; a fire sprinkler system that is filled with water from the public water supply
10	Low head backpressure is intended to mean negligible backpressure in the 1.0 psi to 4.0 psi range, no continuous pressure over 12 hrs.	Wall hydrant hose bib
11	Continuous pressure is OK because the air-inlet and check valve are spring-loaded	Irrigation systems, plating tanks, livestock watering systems, supply to a submerged inlet

<b>12</b>	Constructed of non-copper material	Installed, on the water supply line to carbonated beverage dispensers prior to the carbonating point, no copper beyond this device
<b>13</b>	Low hazard cross-connections, continuous pressure, backsiphonage and backpressure	Residential water service connections, individual outlets
<b>14</b>	Usually a ball-type check valve	Installed inside the post-mix type carbonated beverage dispensers, by the beverage maintenance personnel
<b>15</b>	Low head backpressure is intended to mean negligible backpressure in the 1.0 psi to 4.0 psi range, no continuous pressure over 12 hrs	Laboratory faucets
<b>16</b>	Low head backpressure is intended to mean negligible backpressure in the 1.0 psi to 4.0 psi range, no continuous pressure over 12 hrs	Hose bib connections
<b>17</b>	Used in areas where water spillage may present a problem	X-ray or photo developing machines

**204.08 Installation**

A. Backflow Prevention Devices required by these Rules and Regulations shall be installed after the meter at the expense of the water Consumer. For detailed instruction refer to the Division of Water Distribution's Standard Detail Drawing - Backflow Prevention Setting and Installation Rules.

B. The installation of Backflow Prevention Devices in the City service territory must be by a plumbing contractor licensed by the State and an approved Backflow Prevention Device installer.

C. Backflow Prevention Devices shall be installed on the Customer's side of the water meter as close to the meter as reasonably practical and prior to any other connection.

D. Reduced Pressure Principle Backflow Prevention Assemblies must be installed above ground level or floor level, whichever is higher.

**204.09 Inspection and Maintenance**

A. It shall be the duty of the Consumer at any Premises on which Backflow Prevention Devices required by these Rules and Regulations are installed to have inspections, tests, and repairs made in accordance with the following schedule, or more often where inspections indicate a need:

1. Fixed Air Gap Separation shall be inspected at the time of installation and at least every twelve (12) months thereafter;

2. Double Check Valve Assemblies shall be inspected and tested for tightness at the time of installation and at least every twelve (12) months thereafter.

3. Reduced Pressure Principle Backflow Prevention Assemblies shall be inspected and tested for tightness at the time of installation and at least every twelve (12) months thereafter.

4. Pressure vacuum breakers shall be inspected and tested for capability to prevent back-siphonage at the time of installation and at least every twelve (12) months thereafter and rebuilt whenever needed. The assembly shall be routinely inspected at least every three (3) months by the Owner for visible conditions which would or could prevent the normal functioning of the assembly.

5. Interchangeable Connections and low pressure cut-offs shall be inspected at the time of installation and at least every twelve (12) months thereafter.

B. Inspections, tests and rebuilding of Backflow Prevention Devices shall be made at the expense of the water Consumer and shall be performed by a State of Ohio, Certified Backflow Tester who must also be registered with the Division of Water Distribution. The Department may charge a registration fee.

C. Whenever Backflow Prevention Devices required by these Rules and Regulations are found to be defective, they shall be repaired or replaced without delay at the expense of the Owner.

D. The City must maintain a complete record of each Backflow Prevention Device. This shall consist of a comprehensive listing that includes a record of all tests, inspections, repairs and rebuilds. Records of inspections, tests, repairs and rebuilds shall be submitted to the Director.

E. Backflow Prevention Devices shall not be bypassed, made inoperative, removed or otherwise made ineffective without specific authorization by the Director.

#### **204.10 Booster Pumps**

A. Fire suppression systems containing booster pumps installed after the effective date of OAC 3745-95-07 shall include a minimum pressure-sustaining valve, which shall be set to close, should the supply pressure drop below 10 psi. Where a booster pump has been installed prior to the effective date of OAC 3745-95-07 on the Service Line to or within any Premises, such pump shall be equipped with a low pressure cut-off device designed to shut-off the booster pump when the pressure in the Service Line of the suction side of the pump drops to ten (10) pounds per square inch gauge or less.

B. It shall be the duty of the water Consumer to maintain the minimum pressure sustaining valve or low pressure cut-off device in proper working order and to certify to the Water Purveyor, at least one a year, that the device is operating properly.

## **204.11 Violations**

A. The Department may deny or discontinue water service to any Premises, after reasonable notice to the occupants, where any Backflow Prevention Device required by these Rules and Regulations is not installed, tested and maintained in a manner acceptable to the Director; or if it is found that the Backflow Prevention Device has been removed or by-passed, or if an unprotected Cross-Connection exists on the Premises, or if a minimum pressure sustaining valve or low pressure cut-off required by these Rules and Regulations is not installed and maintained in working order or for any other violation of the foregoing regulations regarding backflow prevention.

B. Water service to such Premises shall not be restored until the Consumer has corrected or eliminated the conditions or defects in these Rules and Regulations and to the satisfaction of the Director.

## **CHAPTER 205 WATER SERVICE MAIN EXTENSIONS**

### **205.01 Location and Size Of Water Mains**

A. Both water service and trunk mains shall be located and sized as determined by the Director based on engineering considerations.

B. Unless special conditions warrant the installation of smaller water service mains, or increased volume of water needs by Customers require larger mains, all mains for direct service to Customers shall be eight inches (8") in size.

C. In cases where mains must be larger than eight inches (8") to also perform the function of trunk mains, combination service-trunk mains up to twelve inches (12") in size may be constructed.

D. Whenever the Director deems it necessary, water mains shall be extended beyond the limits of the project so as to eliminate dead ends and the costs of such extensions shall be included with the costs of the entire project.

E. Water service mains shall be constructed along the full frontage of all platted properties. Water service mains along unplatted and undeveloped properties may be constructed to a point selected by the Director. The Director may require water services to be constructed along the full frontage of unplatted and undeveloped properties.

F. In special cases, the Director may waive the above requirements, when there is no

possibility of a water service main being needed beyond the Premises. However, the requirement that no Premises shall be served with water until an equitable and equivalent payment for a water service main has been made shall not be abrogated.

### **205.02 Procedure For Extension Of Water Mains Within The City**

Unless otherwise provided by ordinance, extensions of water mains within the City's corporate limits shall be performed by the applicant under a license agreement or by the City on a cash basis, an assessment basis, a pay-cash-to-tap basis or some combination of these as determined by the Director.

#### **A. License Agreement**

1. Plans for the proposed water main extension shall be submitted to the Director for review and approval. Design and construction shall be in conformance with the latest version of the City's "Infrastructure Design and Construction Requirements." Payment of the plan review and inspection fee shall be required prior to plan approval, in accordance with these Rules and Regulations. The applicant is responsible for obtaining approval from the OEPA and all other third-party approvals.

2. A License Agreement on a form provided by the Director shall be executed to, without limitation, authorize construction in the public right-of-way, require applicant reimbursement of testing costs, indemnify the City, stipulate insurance requirements, require a maintenance bond, and dedicate ownership of improvements to the City.

3. Applicant shall contract for construction of the main extension. The Director through Water Distribution and/or contract services will inspect all construction.

4. A contractor must make all connections to existing mains. The City must inspect prior to contractor backfilling connections.

5. As-built record drawings shall be completed by the applicant and submitted to the Director on mylar and in digital format.

#### **B. Cash Basis**

1. Upon receipt of a petition signed by Owners of property requesting installation of a water main, if the Director agrees to proceed on a cash basis, the Director will calculate the amount of an advance deposit to be paid by the petitioners based upon the lineal footage of water main to be constructed, plus a charge to cover the City's cost of preparing the plans and estimates. The unexpended balance of the deposit will be credited to the petitioners' accounts or returned upon the request of the petitioners.

2. After the plans and estimates have been prepared by the City's Engineer and approved by the OEPA, the Director shall submit legislation to City Council appropriating money and authorizing construction of the water main.

3. After enactment of the legislation, the petitioners shall deposit their portion of the costs of the water main as estimated by the Director. The Director may then proceed to solicit bids for the construction of the water main or initiate construction itself.

4. Upon the completion of all construction work, sterilization and testing, the Director shall compile the final project costs and calculate the actual charge owed by the petitioners. If the final charge to the petitioners is less than the deposit, the unused portion will be returned. If the final charge to the petitioners is greater than the deposit, the additional amount shall be paid to the City before any applications for service will be accepted.

### C. Assessment Basis

1. Upon receipt of a petition signed by the Owners of property fronting on and benefiting from a proposed water main, the Director shall submit legislation to City Council authorizing the preparation of plans and estimates.

2. After the plans and estimates have been prepared by the City's Engineer and approved by the OEPA, the Director shall submit a resolution of necessity to City Council containing the information required by law. A copy of the plans and estimates prepared for the proposed project shall be kept on file with the Department for inspection during working hours by all interested parties.

3. The Director or his designee shall prepare an assessment report to be filed with City Council and shall serve a notice upon the Owner of each parcel of land to be assessed containing a statement of the character of the improvement, the rate of assessment, the number of installments and the time and place when complaints and claims may be presented to Assessment Equalization Board.

4. After City Council enacts an ordinance levying the assessments reported by the Assessment Equalization Board and determines to proceed with the improvement, the Director shall solicit bids for the construction of the water main or initiate construction by the Division of Water Distribution. In the event the lowest and best bid exceeds the estimated cost of the improvement by fifteen percent (15%) or more, the contract shall not be entered into until a public hearing is held pursuant to ORC ' 727.24, and City Council subsequently determines that the improvement shall be made.

5. Upon the completion of all construction work, sterilization and testing, the Director shall compile the final project costs and increase or decrease the assessments proportionately in accordance with the approved method of assessment. The revised assessments shall be



submitted to City Council for approval and, when adopted, shall be published as required by ORC ' 727.26. Unless revised pursuant to ORC ' 727.251, the approved assessments shall be certified to the county auditor for placement on the tax duplicate as provided by law.

D. Pay-Cash-to-Tap Basis

1. Upon receipt of a petition signed by Owners of property requesting installation of a water main, if the Director agrees to proceed on a pay-cash-to-tap basis, the Director will submit legislation to City Council authorizing the preparation of plans and estimates.

2. After the plans and estimates have been prepared by the City's Engineer and approved by the OEPA, the Director shall submit a resolution of necessity to City Council containing the information required by law. A copy of the plans and estimates prepared for the proposed project shall be kept on file with the Department for inspection during working hours by all interested parties.

3. The Director shall prepare a pay-cash-to-tap report to be filed with City Council and shall serve a notice upon the Owner of each parcel of land to be specially benefited by the improvement containing a statement of the character of the improvement, the cost to each benefited property, the interest rate applicable from the installation date of the water main, the maximum number of years that interest will be charged and the time and place when complaints and claims may be presented to the Assessment Equalization Board.

4. After City Council enacts an ordinance approving the pay-cash-to-tap charges reported by the Assessment Equalization Board and determines to proceed with the improvement, the Director may solicit bids for the construction of the water main or initiate construction by Water Distribution. In the event the lowest and best bid exceeds the estimated cost of the improvement by fifteen percent (15%) or more, the contract shall not be entered into until a public hearing is held pursuant to ORC ' 727.24 and City Council subsequently determines that the improvement shall be made.

5. Upon the completion of all construction work, sterilization and testing, the Director shall compile the final project costs and increase or decrease the pay-cash-to-tap charges proportionately in accordance with the approved method of assessment. The revised pay-cash-to-tap charges shall be submitted to City Council for approval and, when adopted, shall be published as required by ORC ' 727.26.

6. No application for connection to the water main constructed under this section shall be accepted until the property Owner has paid the full amount of the pay-cash-to-tap charge approved by City Council plus all applicable interest charges.

**205.03 Procedure For Extension Of Water Mains in Areas Outside The City Limits**

A. All requests for connection to, or extension of, City water mains outside the City should first be presented to the Ottawa County Sanitary Engineer for notice purposes. No construction, extension, or modification of City supplied water distribution facilities located outside the City, shall commence without the approval of the Director and the City Council.

B. The applicant or requesting party shall submit plans for the connection or extension, along with payment of the fee established in these Rules, to the Director for review and approval. Design and construction shall be in conformance with the latest version of the City's "Infrastructure Design and Construction Requirements."

C. When required by the Director, the Applicant/requesting party shall prepare a feasibility report of the effects of the connection or extension on the City's water system and submit said report to the Director for review and approval prior to commencing construction.

D. All construction shall be in accordance with applicable City standards in effect at the time. All construction work shall be at the expense of the applicant.

E. After receiving the City's approval, the applicant/requesting party shall submit the plans to and obtain the approval of the OEPA.

F. The applicant/ requesting party shall obtain all easements, rights-of-way, road-opening permits and any other authorization necessary for completion of the work, and shall be solely responsible for all costs, construction practices and restoration requirements imposed herein.

G. The City and any other responsible governmental authority shall provide inspection of the construction of water main connections or extensions to insure compliance with the approved plans, specifications and City standards. The City reserves the right to also inspect the work to verify compliance with City standards. Inspection by the City shall not relieve the applicant or the contractor from the responsibility to provide a properly constructed water main. Any work which is rejected or which does not conform to the approved plans shall be removed immediately and replaced in an acceptable manner.

H. Upon completion of the water main extension, the applicant/requesting party shall provide the Director with advance notice of the pressure/leakage test and the bacteriological test.

I. The applicant/requesting party shall advise the Director that it has accepted the project and shall furnish two (2) sets of as-built record drawings of the water main extension to the Department (one for the Directors and one for Water Distribution). When all of the requirements established by this section have been successfully completed the Department may accept applications for water.

J. The procedure for large taps and construction of private water mains and fire lines in

areas outside the City shall be in accordance with these Rules and Regulations.

#### **205.04 New Subdivisions**

The following procedure shall be followed for new subdivisions:

- A. A developer who is planning a new subdivision or an extension of an existing subdivision shall hire a professional engineer, registered in the State of Ohio, to design the water main extension, and submit the plans and specifications to Director for review and approval. Design and construction shall be in conformance with the latest version of the City's "Infrastructure Design and Construction Requirements."
- B. Payment of the plan review and inspection fee shall be required prior to plan approval, in accordance with these Rules and Regulations.
- C. The developer is responsible for obtaining approval from the OEPA.
- D. A License Agreement on a form provided by the Director may be required to, among other matters, authorize construction in the public right-of-way, require applicant reimbursement of testing costs, indemnify the City, stipulate insurance and escrow requirements, require a maintenance bond, and dedicate Ownership of improvements to the City.
- E. In the event the property proposed to be developed fronts on a public right-of-way which has an existing water main installed under an assessment or pay-cash-to-tap basis, the developer shall pay the applicable charge as required by ordinance or agreement.
- F. The developer shall obtain all property rights, easements, rights-of-way, road-opening permits and any other authorization necessary for completion of the work, and shall be solely responsible for all costs, construction practices and restoration requirements imposed therein.
- G. The developer shall contract for construction of the main extension. The construction of the water main extension shall be subject to inspection by the City to ensure compliance with the approved plans, specifications and City standards. Inspection by the City shall not relieve the applicant or the contractor from the responsibility to provide a properly constructed water main. Any work which is rejected or which does not conform to the approved plans shall be removed immediately and replaced in an acceptable manner.
- H. Water Distribution will make all taps into existing mains.
- I. Upon completion of the water main extension, the applicant or contractor shall provide the Director with advance notice of the pressure/leakage test and the disinfection of the water main. The Developer or its designated agent shall perform the required bacteriological testing of the main extension prior to connection with the water system.

J. When all of the requirements established by this section have been successfully completed, the Department will accept applications for water service from the new water main.

K. As-built record drawings shall be completed by the applicant and submitted to the Division of Engineering Services on mylar and in digital format.

## **CHAPTER 206 WATER MAINS**

### **206.01 Ownership and Maintenance of Water Main**

A. In general, all public water mains located within the City corporate limits are the property of the City; and all public mains located outside the City corporate limits are the property of the county or the political subdivision in which they are located, unless otherwise agreed to in writing by the City.

B. Maintenance on all water mains within the City's water distribution system shall be repaired by water distribution operators, unless; The city of Port Clinton is under contract with a contractor doing upgrades to the Water Distribution system.

## **CHAPTER 207 RIGHTS OF ENTRY**

### **207.01 Right of Entry onto Private Property**

The Director reserves the right, through authorized representatives, to enter onto the Premises at a reasonable hour of the day for the purpose of designing, repairing, installing, re-installing, removing, maintaining and inspecting the Premises' connection to or impact on the Sanitary Sewer System, water system or Storm Water System within the City's service territory.

**City of Port Clinton**

**Appendix “A”**

**Water System Rates**



# PORT CLINTON WATER DEPARTMENT

**1868 East Perry Street  
Port Clinton, OH 43452**

**Phone 419-734-5522  
Fax 419-734-5278**

## City of Port Clinton – Water Rates

**Effective January 20, 2025  
2025 Water Increase 2%**

The rates for Municipal water service shall be in accordance with the following schedule of rates:

**First 4800 Cubic Feet @ \$6.48 per 100 cubic feet  
Over 4800 Cubic Feet @ \$3.95 per 100 cubic feet**

### Minimum Charges Based on Meter Size

5/8"	5 CCF	\$ 32.40
3/4"	5 CCF	\$ 32.40
1"	12 CCF	\$ 77.76
1 1/2"	25 CCF	\$ 162.00
2"	40 CCF	\$ 259.20
3"	75 CCF	\$ 417.69
4"	125 CCF	\$ 615.19
6"	250 CCF	\$1,108.94

In case two or more units are served by one meter, charge will be made for each unit as if a separate meter was installed with a separate minimum charge for each unit.

### Water Tank Sales

Twenty-five Cents (\$.25) per 40 gallons

### Water Connection Fees

Ordinance No. 15-11 Passed 5/11/2021

150% SURCHARGE OUTSIDE CITY BOUNDARIES

Total Tap In Charge Calculated: Base Rate X Equivalency Factor X Number of Units

Total Impact Fee Calculated: Base Rate X Equivalency Factor X Number of Units

This fee must be paid before the connection can occur.

Permit Fee (Valid 120 days)	\$ 50.00
Repair Permit Fee	\$ 50.00
Renewal Permit Fee	\$ 25.00
Inspection Fee	\$ 100.00
Plan Review/Inspection Fee	\$ 750.00 (Deposit)
Connection Charge (Tap-In Fee)	\$ 515.00/EDU
System Capacity Charge (Impact Fee)	\$ 950.00/EDU

City of Port Clinton  
2025 Water Sewer Rates

Water 2% by SSD - Sewer 2% by Ordinance

CCF	WATER	SEWER	TOTAL		Infrastructure fee	Total
	1/20/2025	1/20/2025			12/23/20	
1	\$6.48	\$13.81	\$20.29	\$73.83	\$12.50	86.33
2	\$12.96	\$27.62	\$40.58	\$73.83	\$12.50	86.33
3	\$19.44	\$41.43	\$60.87	\$73.83	\$12.50	86.33
4	\$25.92	\$55.24	\$81.16	\$87.64	\$12.50	100.14
5	\$32.40	\$69.05	\$101.45	\$101.45	\$12.50	113.95
6	\$38.88	\$82.86	\$121.74		\$12.50	134.24
7	\$45.36	\$96.67	\$142.03		\$12.50	154.53
8	\$51.84	\$110.48	\$162.32		\$12.50	174.82
9	\$58.32	\$124.29	\$182.61		\$12.50	195.11
10	\$64.80	\$138.10	\$202.90		\$12.50	215.40
11	\$71.28	\$151.91	\$223.19		\$12.50	235.69
12	\$77.76	\$165.72	\$243.48		\$12.50	255.98
13	\$84.24	\$179.53	\$263.77		\$12.50	276.27
14	\$90.72	\$193.34	\$284.06		\$12.50	296.56
15	\$97.20	\$207.15	\$304.35		\$12.50	316.85
16	\$103.68	\$220.96	\$324.64		\$12.50	337.14
17	\$110.16	\$234.77	\$344.93		\$12.50	357.43
18	\$116.64	\$248.58	\$365.22		\$12.50	377.72
19	\$123.12	\$262.39	\$385.51		\$12.50	398.01
20	\$129.60	\$276.20	\$405.80		\$12.50	418.30
21	\$136.08	\$290.01	\$426.09		\$12.50	438.59
22	\$142.56	\$303.82	\$446.38		\$12.50	458.88
23	\$149.04	\$317.63	\$466.67		\$12.50	479.17
24	\$155.52	\$331.44	\$486.96		\$12.50	499.46
25	\$162.00	\$345.25	\$507.25		\$12.50	519.75
26	\$168.48	\$359.06	\$527.54		\$12.50	540.04
27	\$174.96	\$372.87	\$547.83		\$12.50	560.33
28	\$181.44	\$386.68	\$568.12		\$12.50	580.62
29	\$187.92	\$400.49	\$588.41		\$12.50	600.91
30	\$194.40	\$414.30	\$608.70		\$12.50	621.20
31	\$200.88	\$428.11	\$628.99		\$12.50	641.49
32	\$207.36	\$441.92	\$649.28		\$12.50	661.78
33	\$213.84	\$455.73	\$669.57		\$12.50	682.07
34	\$220.32	\$469.54	\$689.86		\$12.50	702.36
35	\$226.80	\$483.35	\$710.15		\$12.50	722.65
36	\$233.28	\$497.16	\$730.44		\$12.50	742.94
37	\$239.76	\$510.97	\$750.73		\$12.50	763.23
38	\$246.24	\$524.78	\$771.02		\$12.50	783.52
39	\$252.72	\$538.59	\$791.31		\$12.50	803.81
40	\$259.20	\$552.40	\$811.60		\$12.50	824.10
41	\$265.68	\$566.21	\$831.89		\$12.50	844.39
42	\$272.16	\$580.02	\$852.18		\$12.50	864.68
43	\$278.64	\$593.83	\$872.47		\$12.50	884.97
44	\$285.12	\$607.64	\$892.76		\$12.50	905.26
45	\$291.60	\$621.45	\$913.05		\$12.50	925.55
46	\$298.08	\$635.26	\$933.34		\$12.50	945.84
47	\$304.56	\$649.07	\$953.63		\$12.50	966.13
48	\$311.04	\$662.88	\$973.92		\$12.50	986.42
OVER 48 CCF	3.95/ccf	13.81/ccf	17.76/ccf	*Infrastructure fee - water 6.86/EDU sewer 5.64/EDU		

**\*WATER MINIMUM - \$32.40 AT 5CCF\* \*SEWER MINIMUM - \$41.43 AT 3 CCF\***

\*water & sewer minimum quoted for inside rate single unit with 5/8" or 3/4" meter

**City of Port Clinton**

# **Appendix “B”**

**Schedule of Fees & Charges**



All fees and charges marked with \* are subject to cumulative annual adjustments based on the latest Consumer Price Index reported by the US Bureau of Labor Statistics for CPI-U, Midwest Region, all items (1982-84 = 100), but in no event shall be less than as stated below.

<b>EQUIPMENT OR SERVICE</b>	<b>DETAIL / BY-LAW SECTION</b>	<b>CHARGE</b>
<b>Auxiliary Sewer Deduct Meter</b>	<b>1 time fee added to bill 201.15 (C)</b>	<b>\$25.00 per meter at service address</b>
<b>Cap Off Inspection for Termination of Service/ Demolition of Structure</b>	<b>103.03</b>	<b>\$100.00</b>
<b>Collection Agency Charges (added directly to delinquencies)</b>	<b>106.03</b>	<b>Variable : Dependent on contract</b>
<b>Copy Charge (per page)</b>	<b>\$.05 per page</b>	<b>Greater than 10 pages</b>
<b>Customer Requested Meter Test*</b>	<b>If found to be accurate 104.05 (A), 201.10 (C)</b>	<b>\$25.00</b>
<b>Department Ordered Missed Appointment</b>	<b>102.02 (A), 102.01 (E)</b>	<b>\$25.00</b>
<b>Deposit (Utility Service)</b>	<b>101.02 (D)</b>	<b>Generally 2 Billing Cycles Worth of Usage</b>
<b>Estimated Final Bill (Forced)</b>	<b>102.01 (B)</b>	<b>\$50.00</b>
<b>Estimated Meter Read Charge For Lack of Remote</b>	<b>102.01 (B)</b>	<b>\$50.00</b>
<b>Failure to Provide Meter Access</b>	<b>102.01 (E)</b>	<b>\$50.00</b>
<b>Hydrant Meter Rental</b>	<b>203.01</b>	<b>\$250.00 deposit plus usage @ Current Rate (\$30 Minimum)</b>
<b>Late Payment Charge</b>	<b>104.03 (A) (2) (b)</b>	<b>10%</b>
<b>Lien Charge *</b>	<b>101.02 (K)</b>	<b>\$25.00 Flat Rate</b>
<b>On/Off fee - Permanent</b>	<b>Set by Ord. 43-97</b>	<b>\$30.00</b>
<b>On/Off fee - Temporary</b>	<b>Inspection</b>	<b>\$50.00 Flat Rate</b>
<b>On/Off fee - After Hours</b>	<b>Set by Ord. 43-97</b>	<b>\$75.00</b>
<b>Returned Check/ACH - Any Reason</b>	<b>Set by Auditor's Office</b>	<b>\$40.00</b>
<b>Tampering with Meter (Removing)</b>	<b>201.11</b>	<b>Resealing charge \$50.00</b>
<b>Tampering with Meter, Remote, Transmitter or other City Property *</b>	<b>201.11, 106.05, 100.03</b>	<b>Assessed a fee as determined By SSD – Repeat Offense to Result in Prosecution</b>
<b>Repair or Replace Meters Owned by the City *</b>	<b>201.10</b>	<b>Charge based on Current Costs of equipment</b>
<b>Repair or Replace "Radio Read Transmitter" *</b>	<b>201.15 (D), 201.14 (D)</b>	<b>Charge based on Current Costs of equipment</b>
<b>Unauthorized Use of Services</b>	<b>100.03</b>	<b>\$200.00</b>

**City of Port Clinton**

# **Appendix “C”**

**Standard Forms**

# PORT CLINTON WATER WORKS



1868 East Perry Street  
Port Clinton, OH 43452

Phone 419-734-5522  
Fax 419-734-5278

## AUTHORIZATION FOR AUTOMATED BILL PAYMENT

Please complete ALL Sections and return this form:

I authorize the Port Clinton Water Works to instruct my banking/savings institution to make my utility payments from the account listed below. I understand that I control my payments, and, if at any time I decide to discontinue this payment service, I will notify the Port Clinton Water Works in writing. I understand the file is sent to the bank a minimum of three (3) business days prior to the 15<sup>th</sup>.

I understand that there will be a \$40.00 charge, per occurrence, for returned funds during the withdrawal process and that repeated offenses may result in ineligibility for the Automated Payment Plan.

(PLEASE PRINT)

Date: \_\_\_\_\_ Phone: \_\_\_\_\_

Name (please print): \_\_\_\_\_

Service Address: \_\_\_\_\_

Account # as shown on Water Bill: \_\_\_\_\_

Signature: \_\_\_\_\_

### Banking Information: Bank, Savings & Loan, Credit Union

Financial Institution: \_\_\_\_\_

Please circle one:      Checking      Savings

Bank Account # \_\_\_\_\_ Bank Routing # \_\_\_\_\_

**PLEASE INCLUDE A VOIDED CHECK  
IN ORDER TO RECORD THE CORRECT BANKING INFORMATION**  
Please continue to pay until notification is made on your water bill indicating:

**“PAYMENT WILL BE DEDUCTED FROM YOUR ACCOUNT ON .....”**

FOR OFFICE USE ONLY

Entered into MuniLink Date: \_\_\_\_\_ Prenote Sent Date: \_\_\_\_\_

Verified ACH Date: \_\_\_\_\_



**Port Clinton Water Works**

1868 E. Perry St.

Port Clinton, OH 43452

Acct # \_\_\_\_\_

419-734-5522 Fax 419-734-5278

**ADDENDUM TO OWNER CONTRACT FOR THE FOLLOWING SERVICE ADDRESS:**

\_\_\_\_\_  
(Print Service Address)

I, \_\_\_\_\_ request billings be sent to:  
(Print Owner's Name)

the above service address in care of

\_\_\_\_\_  
(Please Print)

the following address

\_\_\_\_\_

\_\_\_\_\_, effective date \_\_\_\_\_

**I understand I am still bound to the terms on the original Owner Contract**

\_\_\_\_\_  
(Owner Signature)

\_\_\_\_\_  
(Date)



# PORT CLINTON WATER WORKS

1868 East Perry Street  
Port Clinton, OH 43452

Phone 419-734-5522  
Fax 419-734-5278

## CATASTROPHIC INCIDENT FORM

Service Address: \_\_\_\_\_ Fire Chief \_\_\_\_\_

Legal Property Owner: \_\_\_\_\_

Account Number: \_\_\_\_\_ Date of Incident: \_\_\_\_\_

Description of Incident: \_\_\_\_\_

\_\_\_\_\_

\_\_\_\_\_

\_\_\_\_\_

Date: \_\_\_\_\_ Signature: \_\_\_\_\_

Print Name: \_\_\_\_\_

### FOR OFFICE USE ONLY

Turn Off Date: \_\_\_\_\_ Meter Reading: \_\_\_\_\_

Final Date: \_\_\_\_\_ Meter Reading: \_\_\_\_\_



# PORT CLINTON WATER WORKS

1868 East Perry Street  
Port Clinton, OH 43452

Phone 419-734-5522  
Fax 419-734-5278

## DISCONTINUATION OF SERVICE AND BILLING

Account Number: \_\_\_\_\_

Service Address: \_\_\_\_\_

Legal Property Owner: \_\_\_\_\_

To discontinue billing, the city must verify that there was zero (0) consumption registered through the water meter for a minimum of twelve (12) consecutive months. The account balance must be paid in full in addition to a turn off fee (if not already paid).

The meter will remain in place and read monthly. If unauthorized usage is discovered, billing will be re-activated and a fee of two hundred dollars (\$200.00) will be charged for the "unauthorized use of service". Any and all water used in addition to a turn off fee will be billed in the next billing cycle.

Monthly billing will resume until there is zero (0) consumption registered through the water meter for a minimum of twelve (12) consecutive months and the account balance is paid in full.

Date: \_\_\_\_\_ Signed: \_\_\_\_\_

Print Name: \_\_\_\_\_

FOR OFFICE USE ONLY - VERIFICATION OF NO USAGE FOR 12 MONTHS

Turn Off Date: \_\_\_\_\_ Meter Reading: \_\_\_\_\_

Final Date: \_\_\_\_\_ Meter Reading: \_\_\_\_\_

# PORT CLINTON WATER WORKS



**1868 East Perry Street  
Port Clinton, OH 43452**

**Phone 419-734-5522  
Fax 419-734-5278**

## HYDRANT METER RENTAL

By-Laws, Section 107.03

CUSTOMER NAME: \_\_\_\_\_

SERVICE ADDRESS: \_\_\_\_\_

ACCOUNT NUMBER: \_\_\_\_\_

CONTRACTOR NAME: \_\_\_\_\_ PHONE: \_\_\_\_\_

Customers requesting temporary use of water from fire hydrants for construction, demolition or similar purposes are required to pay a deposit on meters and wrenches. A refundable\* deposit of \$250.00 is required prior to picking up the meter. This is payable at the Port Clinton Water Works office.

DATE PAID: \_\_\_\_\_

RECEIPT NUMBER: \_\_\_\_\_

PICK-UP DATE: \_\_\_\_\_

METER READING: \_\_\_\_\_ (gal/ccf)

CURRENT CONDITION OF METER: \_\_\_\_\_

\_\_\_\_\_  
CUSTOMER SIGNATURE

\_\_\_\_\_  
EMPLOYEE SIGNATURE

RETURN DATE: \_\_\_\_\_

METER READING \_\_\_\_\_

RETURNED CONDITION OF METER: \_\_\_\_\_

\_\_\_\_\_  
CUSTOMER SIGNATURE

\_\_\_\_\_  
EMPLOYEE SIGNATURE

REFUND DEPOSIT: YES / NO

\*DEDUCT \$ \_\_\_\_\_ FOR DAMAGES

\*Water billing will be determined by actual usage at current rates or \$30.00 minimum whichever is greater and will be deducted from the deposit.

MAIL REFUND/INVOICE TO: \_\_\_\_\_

# PORT CLINTON WATER WORKS



**1868 East Perry Street  
Port Clinton, OH 43452**

**Phone 419-734-5522  
Fax 419-734-5278**

## KILL PERMIT

By-Laws, Section 103.03

Permission is granted to \_\_\_\_\_

Account Number: \_\_\_\_\_

Service Address: \_\_\_\_\_

### To Kill All Connections:

\_\_\_\_\_ Performed by a Contractor (inspection fee required) \_\_\_\_\_

**Contractor Name**

**Phone**

\_\_\_\_\_ Performed by City (city standard fee – no inspection required - must be 2" or less in diameter)

\_\_\_\_\_ Catastrophic Event (i.e. fire, flood, tornado...) severely damaged/destroyed structure (no fees)

### For:

\_\_\_\_\_ Larger than 1.5" in diameter

Kill Permit Fee: \$ 50.00

\_\_\_\_\_ Less than 1.5" in diameter

Inspection Fee: \$100.00

City Standard Fee: \_\_\_\_\_

### Call for inspection:

**Monday – Friday 7:30 – 2:00**

Make check payable to: **Port Clinton Water Works**

**Total:** \_\_\_\_\_

Permit / Receipt

No. \_\_\_\_\_

Date: \_\_\_\_\_

Expires: \_\_\_\_\_

1 year from issuance

\_\_\_\_\_  
Office Manager



# PORT CLINTON WATER WORKS



**1868 East Perry Street  
Port Clinton, OH 43452**

**Phone 419-734-5522  
Fax 419-734-5278**

## Authorization to Test City Owned Water Meter

Section 201.10 of the Port Clinton Water By-laws states in part "Meters owned by the Department may be tested at the request of the Department or of the Customer. If a Customer asserts a good faith claim that a Department-Owned meter is inaccurate, the Customer may have the meter tested as provided in these Rules and Regulations. Customer requests shall be in writing and shall be accompanied by an authorization to debit the Customer's account according to the schedule of fees and charges (See Appendix B), if required."

I \_\_\_\_\_ request the City of Port Clinton to test the meter at the following service address \_\_\_\_\_.

I understand if the meter tests accurate by the AWA standards there will be a charge of \$25.00 added to my water account.

Account Number: \_\_\_\_\_

Customer Signature: \_\_\_\_\_

Print Name: \_\_\_\_\_

Date: \_\_\_\_\_ Phone #: \_\_\_\_\_

# PORT CLINTON WATER WORKS



1868 East Perry Street  
Port Clinton, OH 43452

Phone 419-734-5522  
Fax 419-734-5278  
pccityhall@portclinton-oh.gov

## OWNER CONTRACT FOR WATER AND/OR SEWER

By-Laws, Section 101.02(B)

Subject to the Rules and Regulations governing the Division of Water and Sewer of the City of Port Clinton, and all ordinances and laws pertaining thereto, now in force or which shall later become in force, the undersigned hereby makes application for water and/or sewer service availability for use at the premises known as: \_\_\_\_\_, and hereby agrees to become responsible for and to make prompt payment of all water and sewer charges and fees connected therewith. No matter how water and sewer usage occurs, the owner assumes ultimate liability for all usage and charges at said premises. The record property owner must sign this contract attesting that all unpaid water and sewer bills, regardless of how the usage occurred, may be assessed as a tax lien against the property served, collectable according to law.

Property is (Please check one): \_\_\_\_\_ Primary Residence \_\_\_\_\_ Seasonal \_\_\_\_\_ Rental

### Owner Information

Name: \_\_\_\_\_

Address: \_\_\_\_\_

Phone: (H) \_\_\_\_\_ (C) \_\_\_\_\_

E-mail: \_\_\_\_\_

Date: \_\_\_\_\_ Signed: \_\_\_\_\_

### Mailing Address/Tenant Info

\_\_\_\_\_ Check here is same as Service Address

Name: \_\_\_\_\_

Address: \_\_\_\_\_

Phone: \_\_\_\_\_ E-mail: \_\_\_\_\_

The Port Clinton Water Department has implemented a new notification system. Please indicate below your preferred method of contact or if you choose to opt out:

Text Message  E-mail  Phone call  Opt-out

Preferred Contact information: \_\_\_\_\_

**PLEASE NOTIFY WATER DEPARTMENT OF ANY CHANGE OF ADDRESS OR TENANT**

Owner, Failure to sign may result in service being denied

For Office Use Only

Account Number \_\_\_\_\_

F:\Shared\Water and Sewer Forms\Owner Contract for Water and Sewer Date Scanned: \_\_\_\_\_



# PORT CLINTON WATER WORKS

Phone 419-734-5522  
Fax 419-734-5278

## CUSTOMER PENALTY WAIVER FORM

*By-Laws Section 104.06*

Customer Name \_\_\_\_\_ Service Address \_\_\_\_\_

Account Number \_\_\_\_\_ Phone Number \_\_\_\_\_

Date \_\_\_\_\_ Signature \_\_\_\_\_

All Bills not paid in full shall be increased by 10% and the amount of the bill as so increased shall constitute the gross bill.

Water and/or Sewer Customers contesting the 10% late penalty charged to their accounts may be granted a one-time waiver of said charge during a one year period providing the following conditions have been met:

1. Requests for waiver must be submitted in writing (see form in Appendix C - Forms), signed and dated by the property owner or person on record with the Department as being responsible for payment; and,
2. Penalty has not been charged within a one (1) year period prior to the request (regardless of the occupant); and,
3. All delinquent charges for water and/or sewer service shall be paid in full prior to the next billing cycle for said service.
4. Request must be received within 30 days of being charged.
5. Submitting a request will not prevent termination of water service

Customer notified on \_\_\_\_\_ of the following decision:

\_\_\_\_\_ Waiver of 10% late penalty granted. Another waiver request will not be considered for a period of one year from date of initial request.

\_\_\_\_\_ Waiver not granted.

\_\_\_\_\_ Previous waiver granted on \_\_\_\_\_

\_\_\_\_\_ Other reason \_\_\_\_\_

Adjustment Amount: \$ \_\_\_\_\_

Date of Adjustment: \_\_\_\_\_

\_\_\_\_\_  
Water Office Manager (or designee)

# PORT CLINTON WATER WORKS



**1868 East Perry Street  
Port Clinton, OH 43452**

**Phone 419-734-5522  
Fax 419-734-5278**

## REQUEST FOR SEWER ADJUSTMENTS

By-Laws, Section 104.05

Owner Name \_\_\_\_\_ Service Address \_\_\_\_\_

Acct No \_\_\_\_\_ Phone \_\_\_\_\_ **(Must be provided)**

I (owner/renter) \_\_\_\_\_ request a sewer adjustment for the following reason:

\_\_\_\_\_ **Water Leak**                      Date discovered \_\_\_\_\_                      Date repaired \_\_\_\_\_

Location & Explanation \_\_\_\_\_  
\_\_\_\_\_  
\_\_\_\_\_

\_\_\_\_\_ **Outside water left on**                      Date discovered \_\_\_\_\_                      Approx how long \_\_\_\_\_

\_\_\_\_\_ Other: Explain and provide date it happened and approximately for how long.  
\_\_\_\_\_  
\_\_\_\_\_

Customer Signature: \_\_\_\_\_ Date: \_\_\_\_\_

For Office Use Only

Approved \_\_\_\_\_ Credit Given(08):\$ \_\_\_\_\_ Office Manager(or designee) \_\_\_\_\_

	<u>Sewer Amt</u>	<u>CCF</u>		<u>Sewer Amt</u>	<u>CCF</u>		<u>Sewer Amt</u>	<u>CCF</u>
	\$			\$			\$	
<b>Should Be</b>	\$		<b>Should Be</b>	\$		<b>Should Be</b>	\$	
<b>Difference</b>	\$		<b>Difference</b>	\$		<b>Difference</b>	\$	

Disapproved \_\_\_\_\_ Reason \_\_\_\_\_

**City of Port Clinton**

# **Appendix “D”**

**Standard Specifications**

**Drawings**

**FIGURE #1**  
**TYPICAL WATER SERVICE LINE**

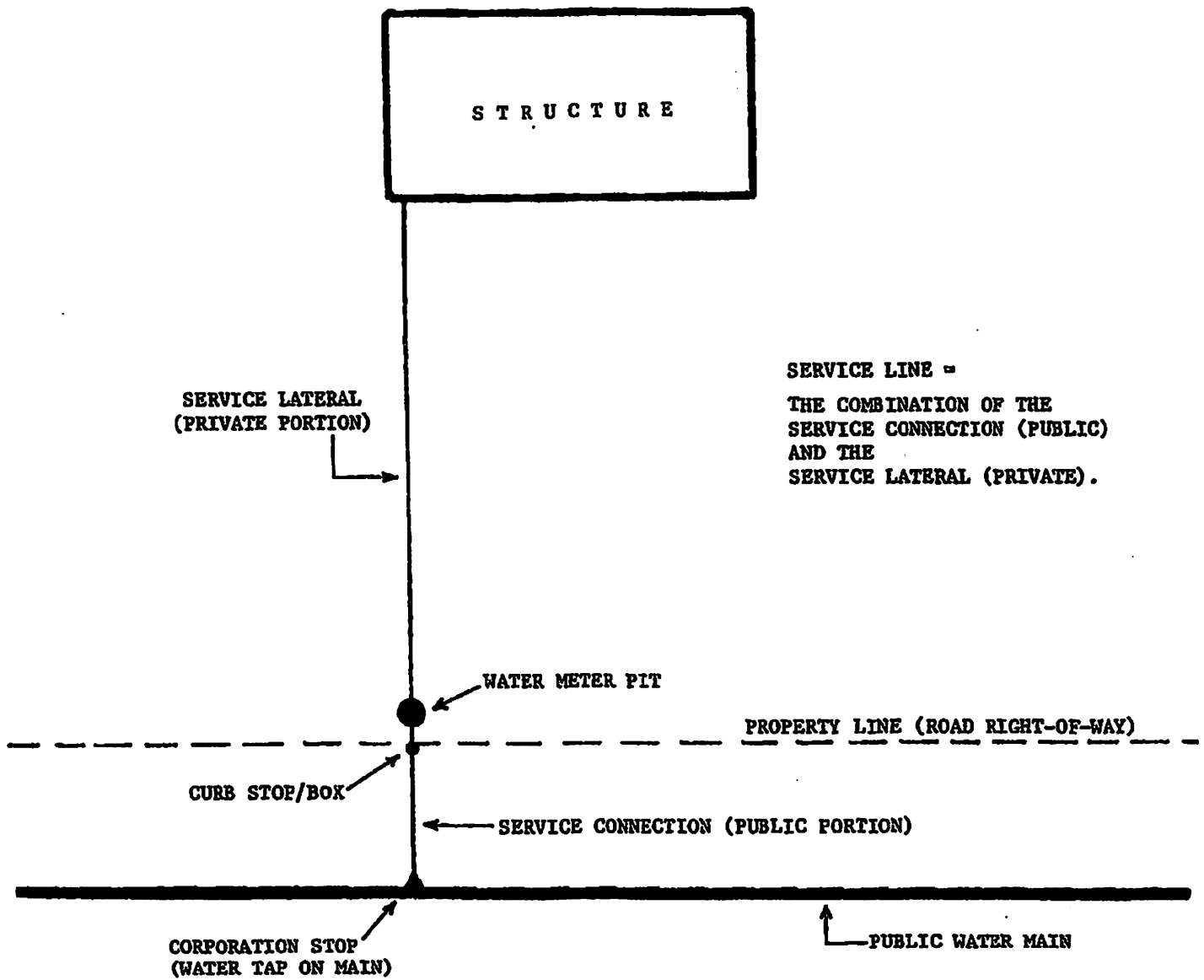

**FIGURE #1**  
**TYPICAL WATER SERVICE LINE**

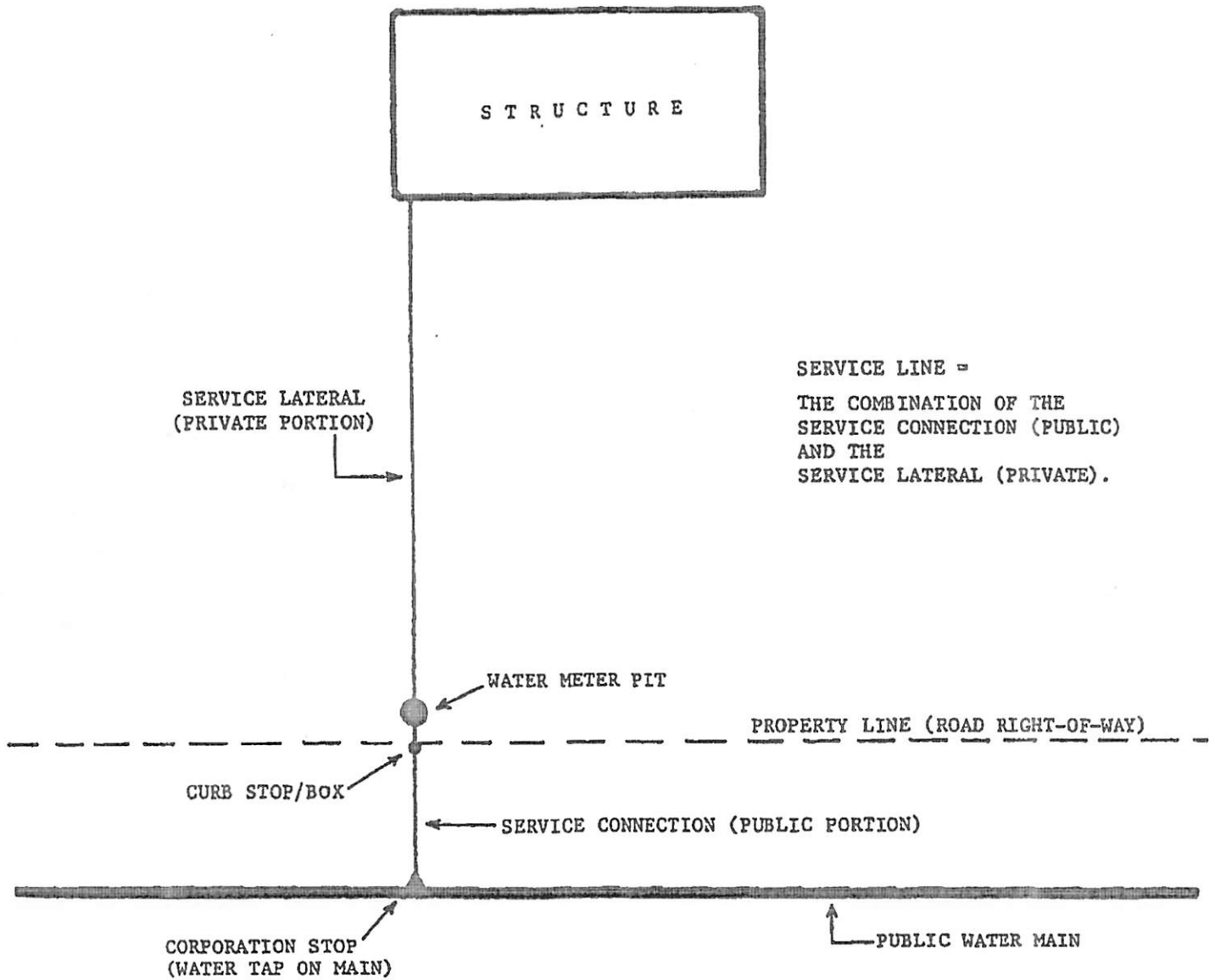

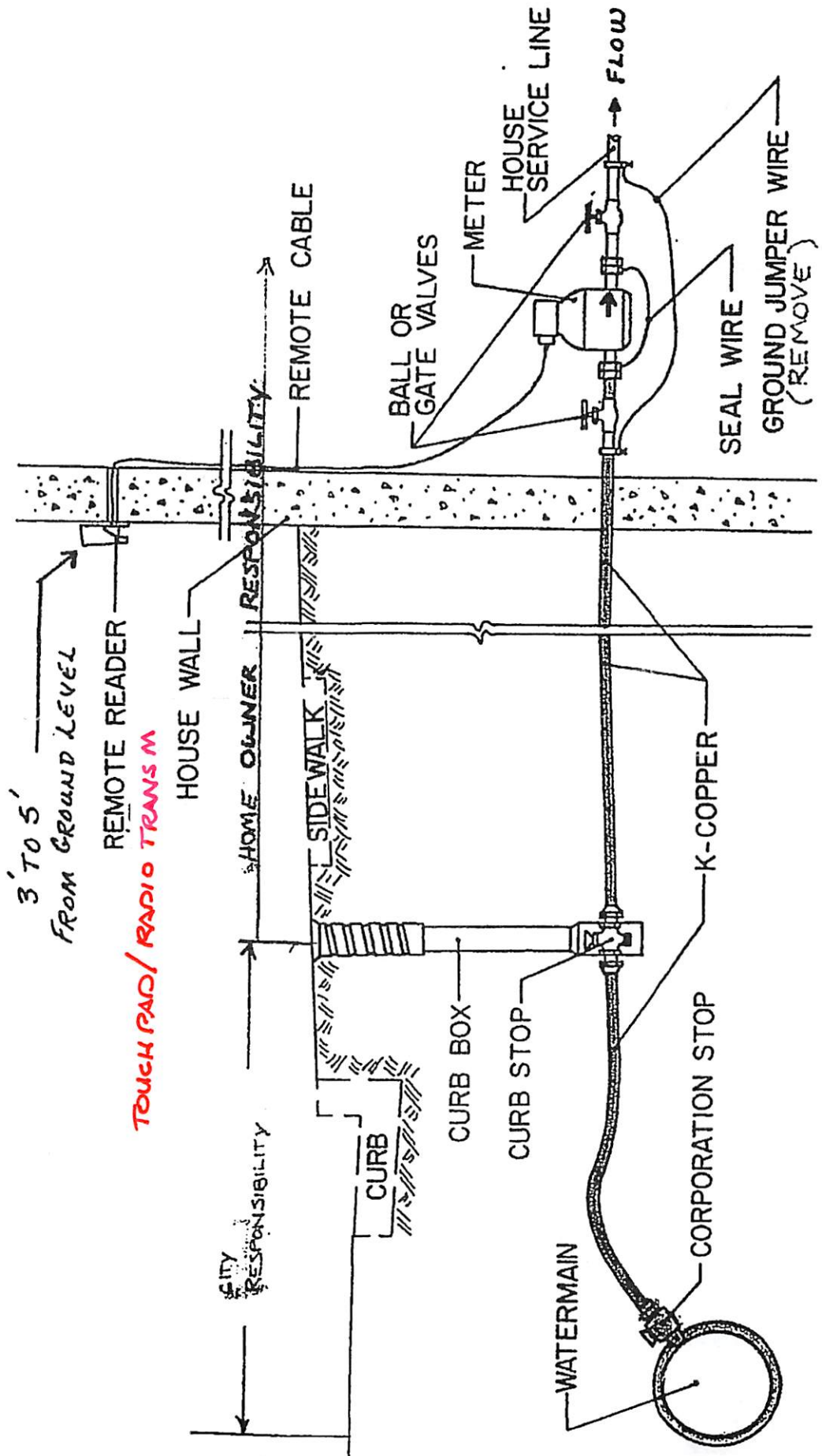

WATER SERVICE - INSIDE METER SETTING



**FIGURE #2**  
**TYPICAL 5/8" X 1/2" METER PIT SETTING/SPECIFICATIONS**  
 PORT CLINTON OHIO

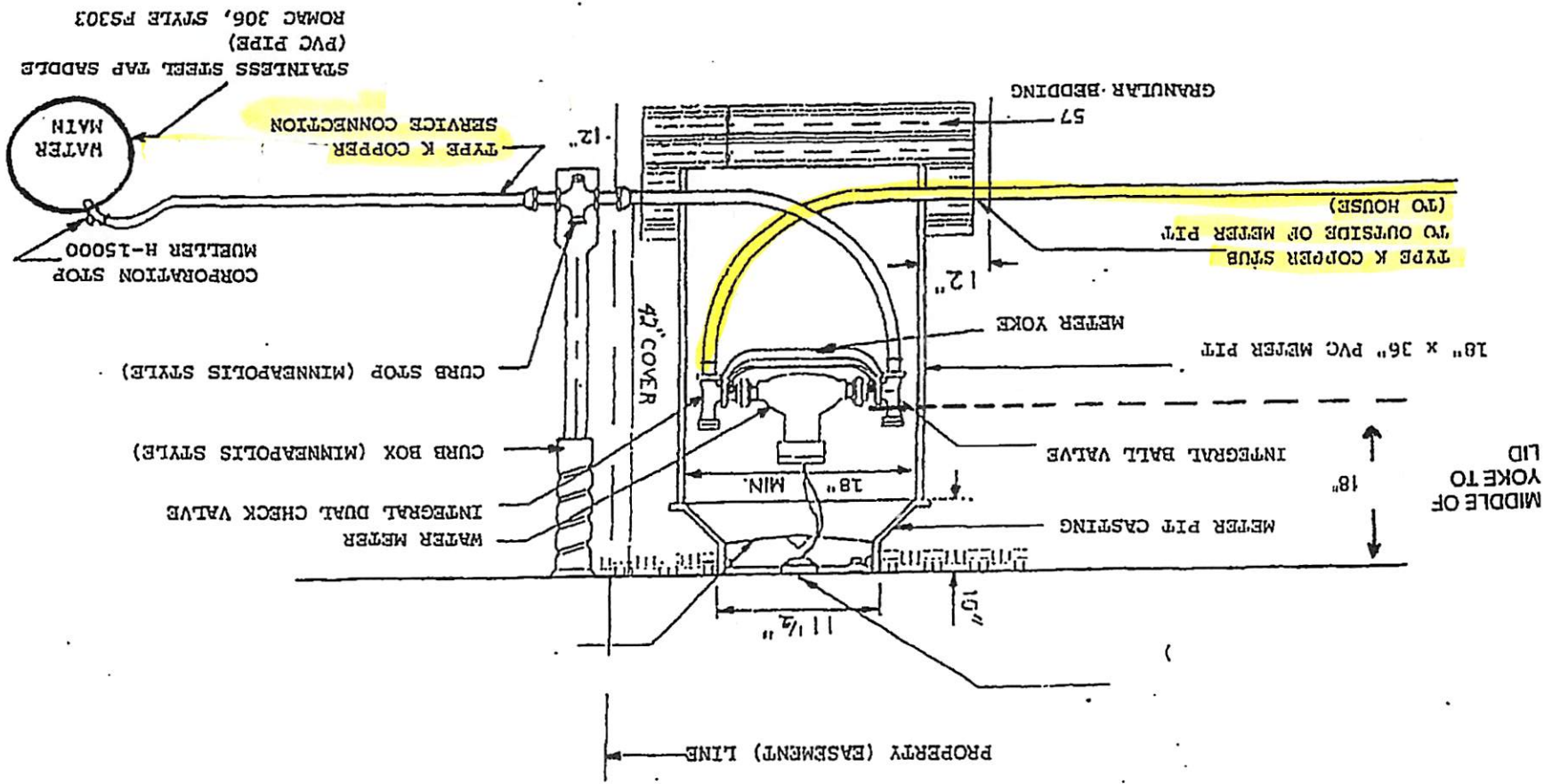

**Specification #'s from HD SUPPLY for Water Pit  
upgrades in the City Of Port Clinton: RESIDENTIAL ONLY**

**Iron Yoke Piece 5/8 Y501**

**Expansion Connection EC-5/8**

**¾ Angle Valve AV94-313WQ**

**HHCA94-313Q 5/8 ANG DUAL**

**CHECK VALVE MTR YOKE x QJ**

**METER PIT MATERIAL**

**18" C32-T TYPE C CVR W/ TRLID**

**18" PRO LINK CORR PIPE**

**FIGURE #2A**  
**TYPICAL 3/4" and 1" METER PIT SETTING/SPECIFICATIONS**  
 PORT CLINTON ; OHIO

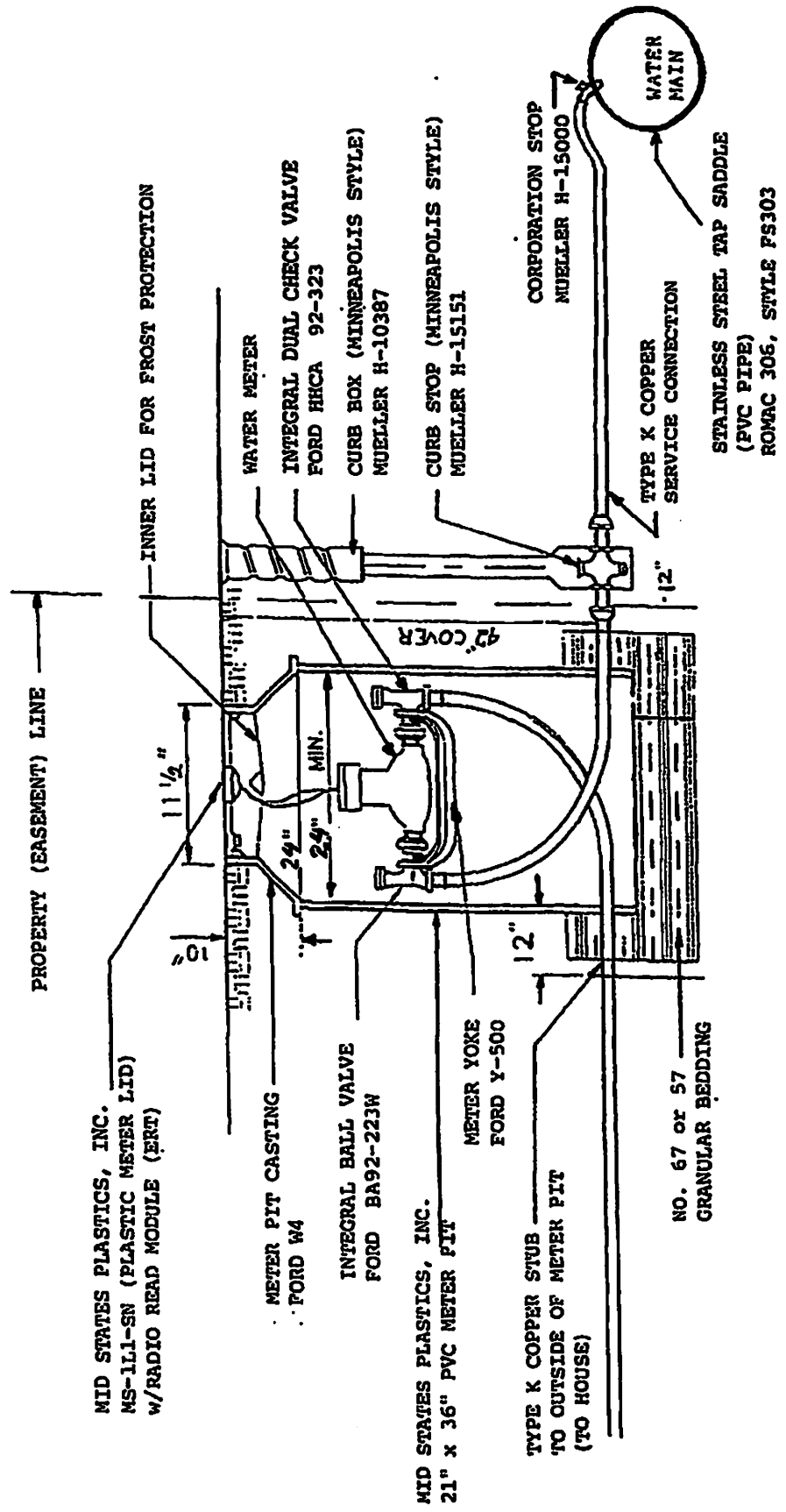

MID STATES PLASTICS, INC.  
 MS-1L1-SN (PLASTIC METER LID)  
 w/RADIO READ MODULE (ERT)

METER PIT CASTING  
 FORD W4

INTEGRAL BALL VALVE  
 FORD BA92-223W

MID STATES PLASTICS, INC.  
 21" x 36" PVC METER PIT

METER YOKE  
 FORD Y-500

TYPE K COPPER STUB  
 TO OUTSIDE OF METER PIT  
 (TO HOUSE)

NO. 67 or 57  
 GRANULAR BEDDING

PROPERTY (EASEMENT) LINE

INNER LID FOR FROST PROTECTION

WATER METER

INTEGRAL DUAL CHECK VALVE  
 FORD HICA 92-323

CURB BOX (MINNEAPOLIS STYLE)  
 MUELLER H-10387

CURB STOP (MINNEAPOLIS STYLE)  
 MUELLER H-15151

CORPORATION STOP  
 MUELLER H-15000

TYPE K COPPER  
 SERVICE CONNECTION

STAINLESS STEEL TAP SADDLE  
 (PVC PIPE)  
 ROMAC 306, STYLE FS303

WATER MAIN

42" COVER

11 1/2"

MIN.

24"

24"

12"

12"

**FIGURE #3**  
**TYPICAL 1 1/2" - 2" METER PIT SETTING**

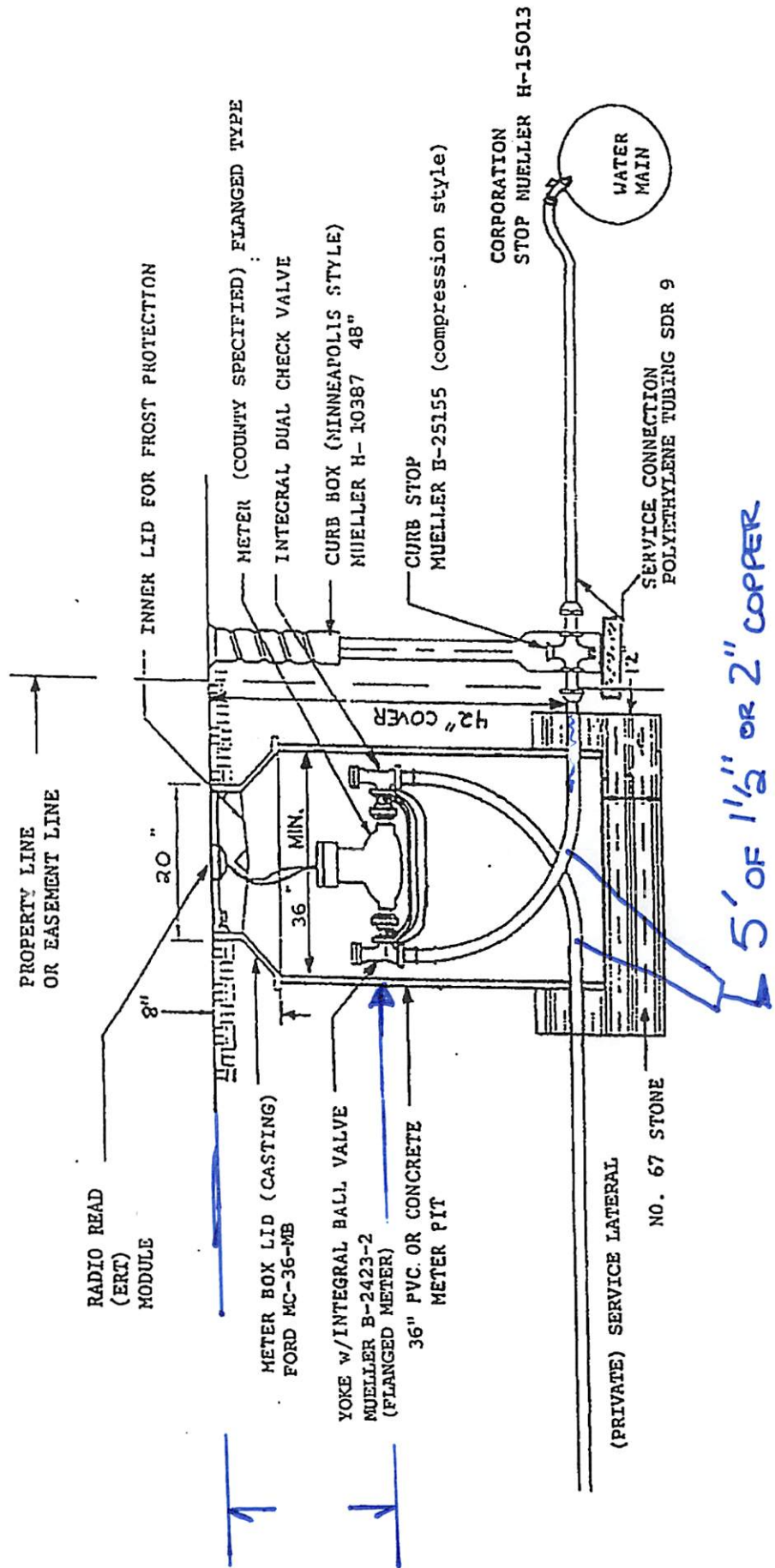

**FIGURE #4**  
**TYPICAL 3" AND LARGER METER VAULT**  
**w/BACKFLOW PREVENTOR, METER, AND BY-PASS**

5/10/01

**OTTAWA COUNTY**

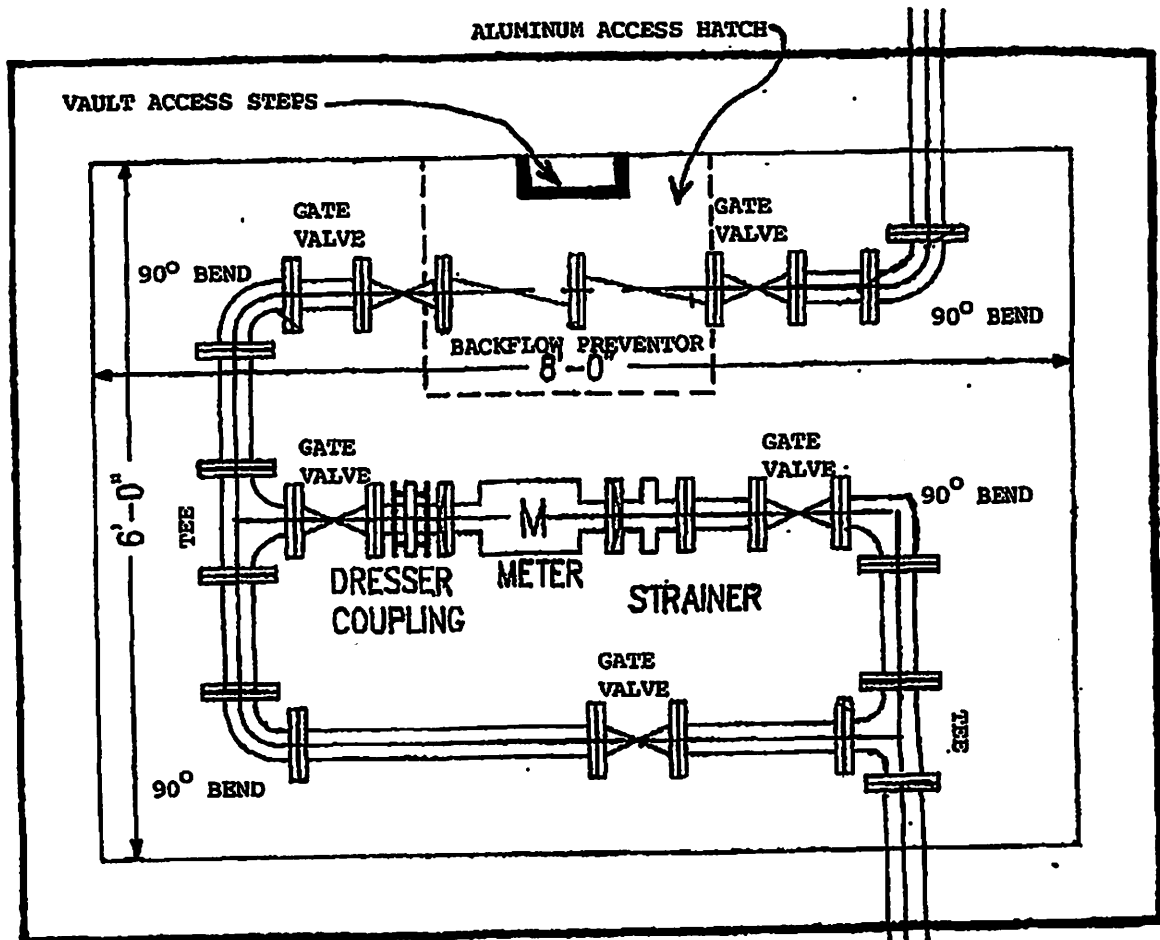

\* A SUMP HOLE SIZED FOR VAULT SHALL BE INCLUDED

**GENERAL NOTES:**

- All piping, valves, and appurtenances within vault are the same diameter/size of service line.
- Vaults for 8" diameter service lines and larger shall require a larger vault than one shown.
- Shop drawings for the vault and all appurtenances must be submitted for approval prior to the issuance of a permit.
- All vaults shall have a concrete floor unless otherwise approved by the Sanitary Engineer.

**FIGURE #5A**  
**(STANDARD) TYPE "A" HYDRANT SETTING**  
**(PERPENDICULAR TO WATER MAIN)**

NOTE: STEAMER NOZZLE SHALL BE 4½"  
 SIDE NOZZLES SHALL BE 2½"  
 STONE FITTINGS ON STEAMER, NOZZLES  
 HYDRANT SHALL BE RED WITH  
 WHITE CAPS AND BONNET (TOP)

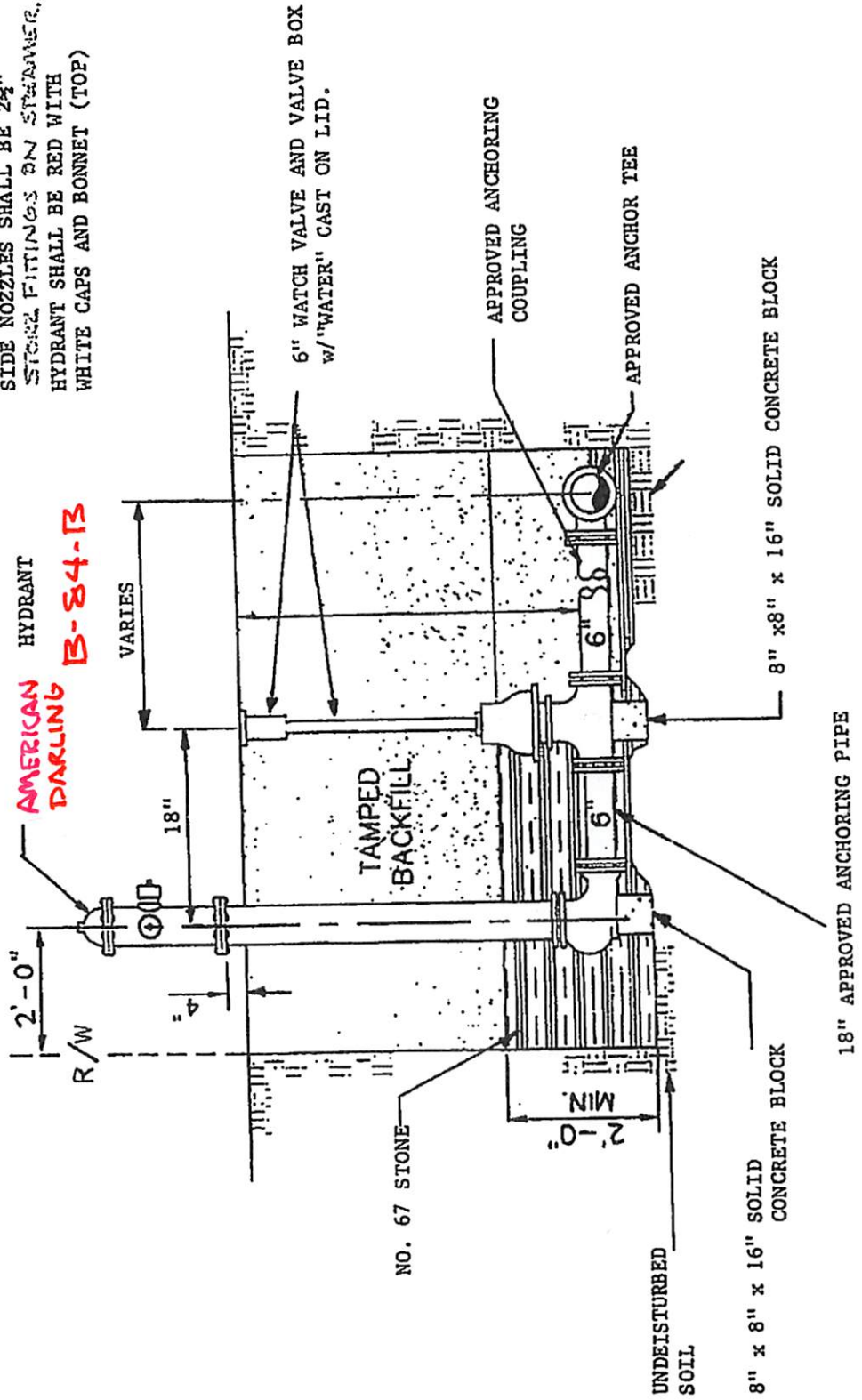

**FIGURE #5B**  
**TYPE "B" HYDRANT SETTING (PARALLEL TO WATER MAIN)**

NOTE: BLOCKING UNDER PIPE AND HYDRANT  
 (STONE DRAIN) SHALL BE  
 8" x 8" x 16" SOLID CONCRETE BLOCKS.  
 (SEE FIGURE #5A FOR LOCATIONS)

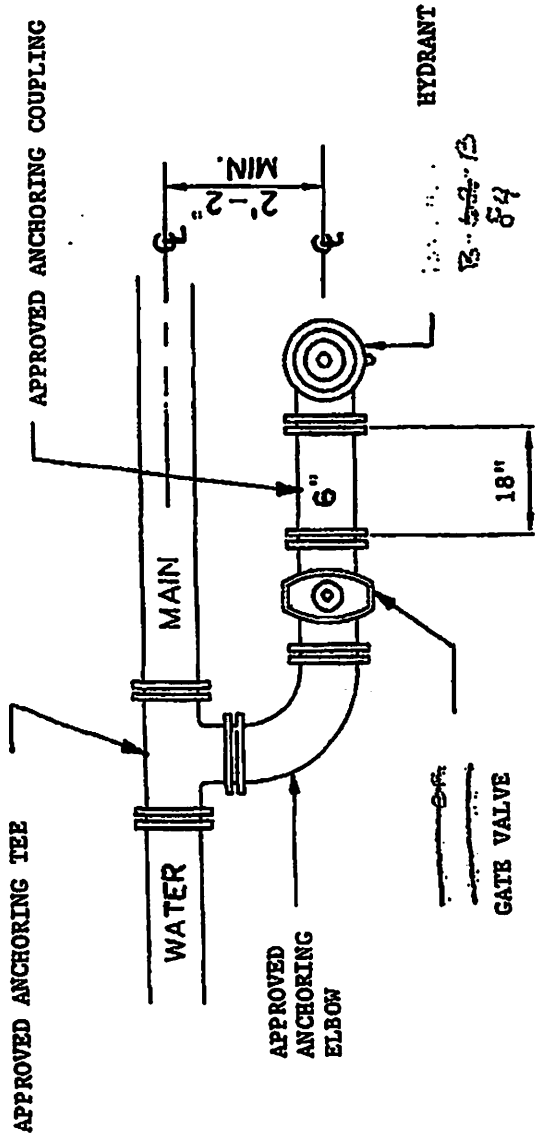

AMERICAN  
 2500 SERIES

**SENSUS**

HATCH = 30" x 30" "BILCO" ALUMINUM (MINIMUM SIZE)  
 VAULT = 5' x 7.1 x 7.1' CONCRETE VAULT WITH SUMP  
 SUMP = 12" DIAMETER x 9" DEEP SUMP HOLE  
 GATE VALVES = 6" KENNEDY W/NON RISING STEMS AND WITH WHEEL HANDLE  
 DETECTOR CHECK VALVE = AMES 300SS OR APPROVED EQUAL  
 INVERTED BY-PASS METER: INVERTED METER W/BCR REGISTER & IRON-ENR  
 SMALL DIAMETER BY-PASS BALL VALVES: FULL STAINLESS STEEL W/HANDLES

**DETAILS:**

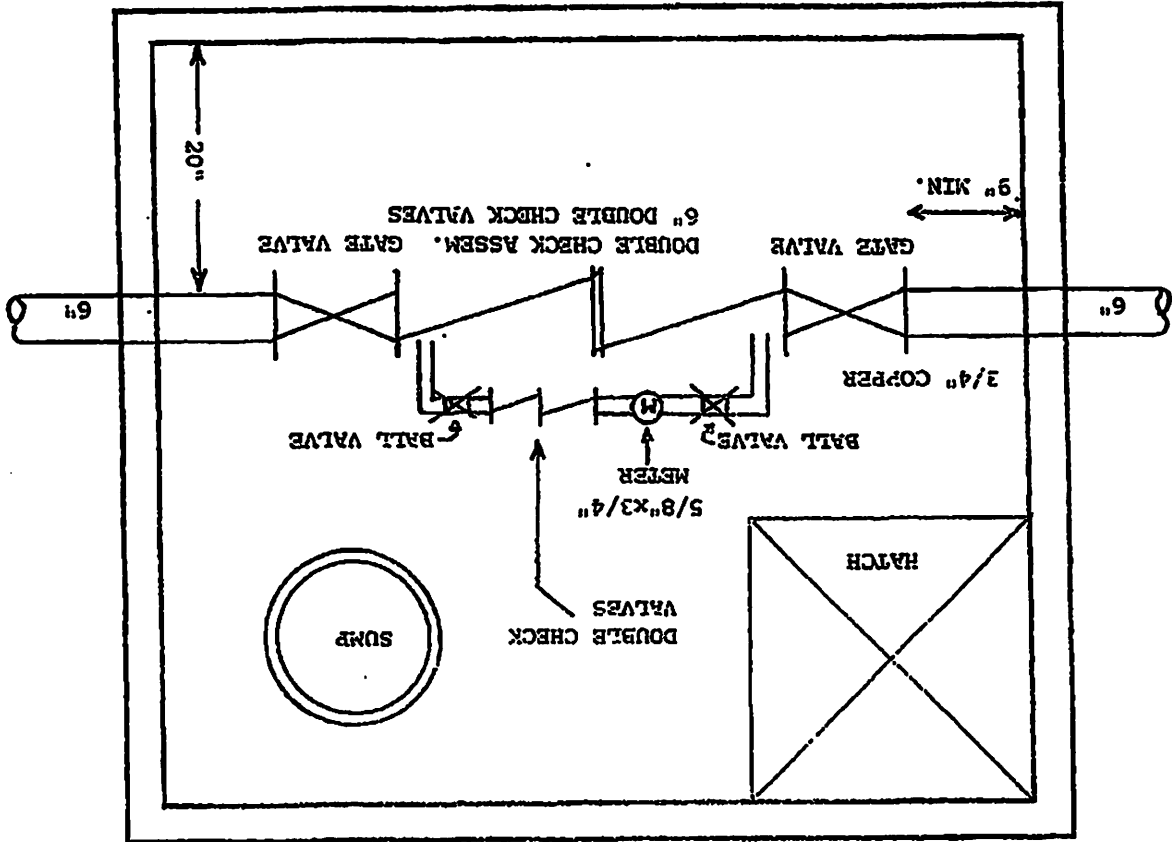

**FIRE LINE DETECTOR CHECK AND VAULT SPECIFICATIONS**

**FIGURE #7**



FIGURE #11

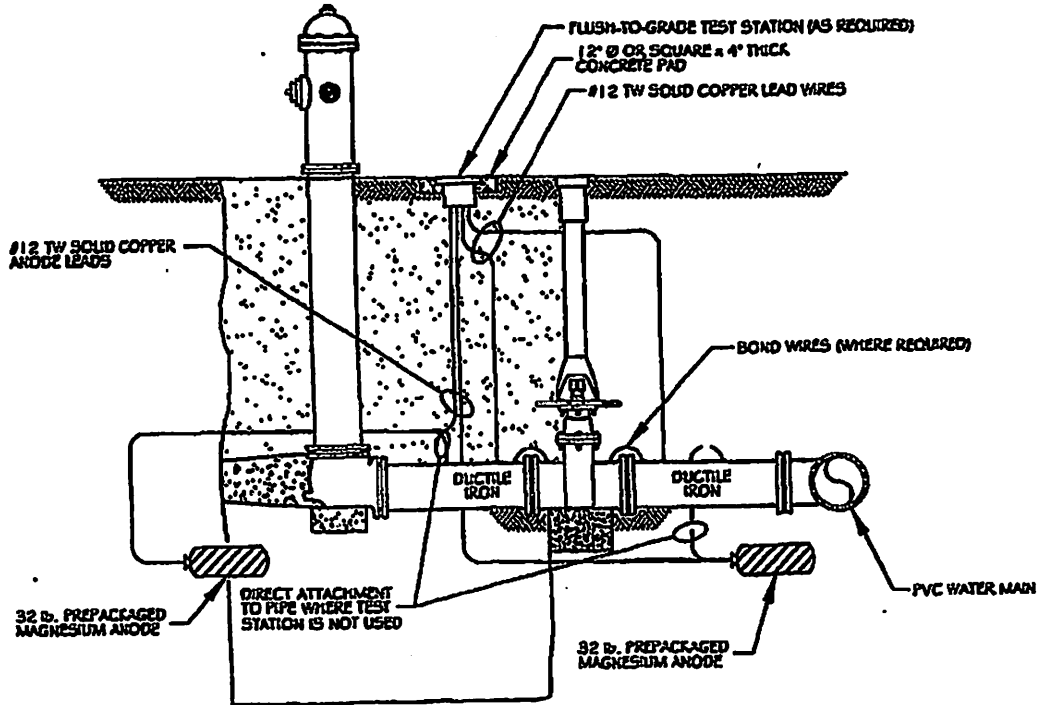

FOR DUCTILE IRON PIPE ADD ADDITIONAL ANODES TO TEE AND PIPING AS SPECIFIED

THIS DESIGN DRAWING IS NOT APPLICABLE FOR USE AS STANDARD CORROSION CONTROL PROCEDURES FOR OTHER PRODUCTS DUE TO VARIABLE CONDITIONS AT OTHER SITES. NEITHER THIS DESIGN NOR ANY PART THEREOF MAY BE DUPLICATED IN ANY WAY FOR OTHER PRODUCTS, EXCEPT BY WRITTEN AGREEMENT WITH CORRPRO COMPANIES INC.

NO.	DATE	BY	REVISION



**CORRPRO COMPANIES, INC.**  
 1055 West Smith Road  
 Medina, Ohio 44258  
 (330) 723-5082

DRAWN BY	J.W.P.
DESIGNED BY	D.F.Z.
DATE	8-29-02
SCALE	NONE
SHEET	1 OF 1
DWG. No.	A1-31957-T

**TYPICAL HYDRANT ASSEMBLY WITH MAGNESIUM ANODES**

**FIGURE #12**

**NOTE: TEST STATIONS SHALL NOT BE LOCATED WITHIN PAVED AREAS.**

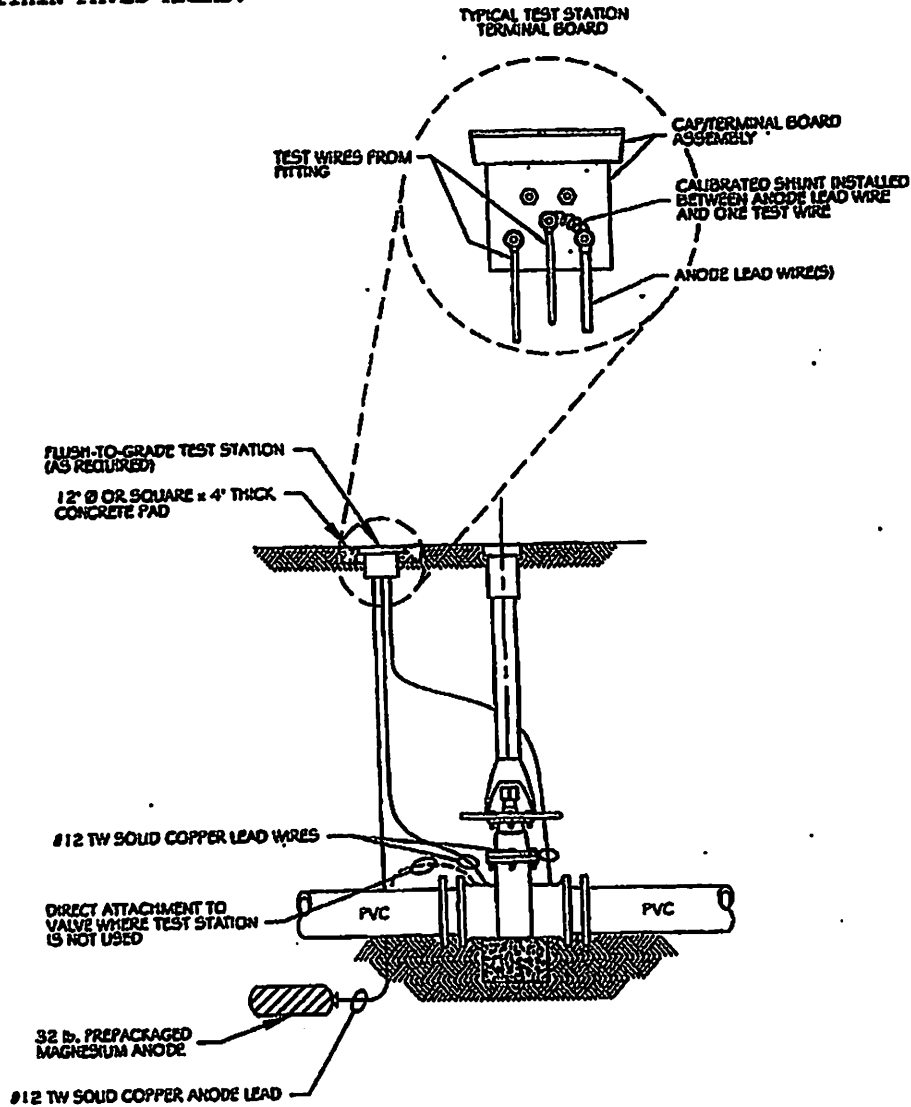

**FOR DUCTILE IRON PIPE ADD ADDITIONAL ANODES TO VALVE AND PIPING AS SPECIFIED**

THIS DESIGN DRAWING IS NOT APPLICABLE FOR USE AS STANDARD CORROSION CONTROL PROCEDURES FOR OTHER PRODUCTS DUE TO VARIABLE CONDITIONS AS OTHER SITES. NEITHER THIS DESIGN NOR ANY PART THEREOF MAY BE DUPLICATED IN ANY WAY FOR OTHER PRODUCTS, EXCEPT BY WRITTEN AGREEMENT WITH CORRPRO COMPANIES INC.

NO.	DATE	BY	REVISION



**CORRPRO COMPANIES, INC.**  
 1055 West Smith Road  
 Medina, Ohio 44258  
 (330) 723-5082

DRAWN BY	J.W.P.
DESIGNED BY	D.F.Z.
DATE	8-29-02
SCALE	NONE
SHEET	1 OF 1
DWG. No.	AI-31958-T

**TYPICAL GATE VALVE WITH MAGNESIUM ANODE**

FIGURE #13

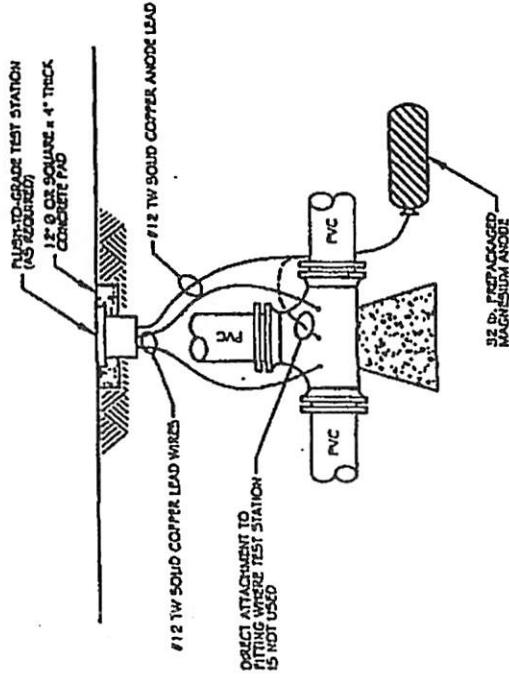

TYPICAL PIPE TEE

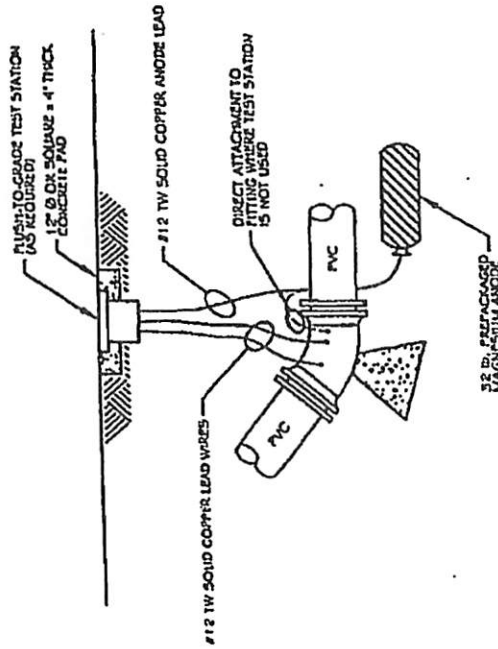

TYPICAL PIPE BEND

FOR DUCTILE IRON PIPE ADD ADDITIONAL ANODES TO PIPING AS SPECIFIED

THIS DESIGN IS NOT APPLICABLE FOR USE AS STANDARD CORROSION CONTROL PROCEDURES FOR OTHER PROJECTS DUE TO VARIOUS CORROSION RATES. NEITHER THIS DESIGN NOR ANY PART THEREOF SHALL BE REPRODUCED IN ANY WAY FOR OTHER PROJECTS, EXCEPT BY WRITTEN AGREEMENT WITH CORRPRO COMPANIES, INC.

DRAWN BY	J.W.F.
DESIGNED BY	D.F.Z.
DATE	8-29-02
SCALE	NONE
SHEET	1 OF 1
DWG. NO.	AI-31959-T

**CORRPRO COMPANIES, INC.**  
 1055 West Smith Road  
 Medina, Ohio 44258  
 (330) 723-5082



REVISION

NO.	DATE	BY

TYPICAL PIPE BEND & PIPE TEE WITH MAGNESIUM ANODE

FIGURE #14

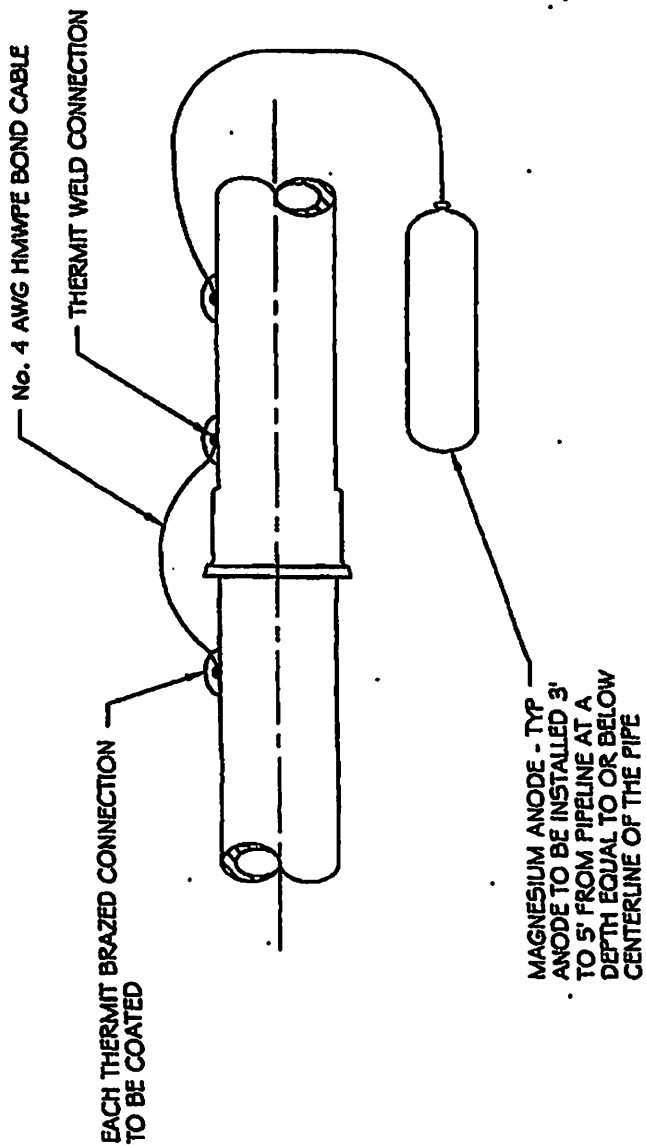

THIS DESIGN IS NOT APPLICABLE FOR USE AS STANDARD CORROSION CONTROL PROCEDURES FOR OTHER PROJECTS DUE TO VARIABLE CONDITIONS AT OTHER SITES. NEITHER THIS DESIGN NOR ANY PART THEREOF MAY BE DUPLICATED IN ANY WAY FOR OTHER PROJECTS, EXCEPT BY WRITTEN AGREEMENT WITH CORRPRO COMPANIES, INC.

DRAWN BY	R.E.C.
DESIGNED BY	D.A.D.
DATE	9-3-91
SCALE	NONE
SHEET	1 OF 1
OVER. NO.	AI-29750-T

TYPICAL  
BONDING AND ANODE INSTALLATION  
AT PUSH JOINT

NO.	DATE	BY	REVISION



**CORRPRO COMPANIES, INC.**  
1055 West Smith Road  
Medina, Ohio 44258  
(330) 723-5082

FIGURE #15

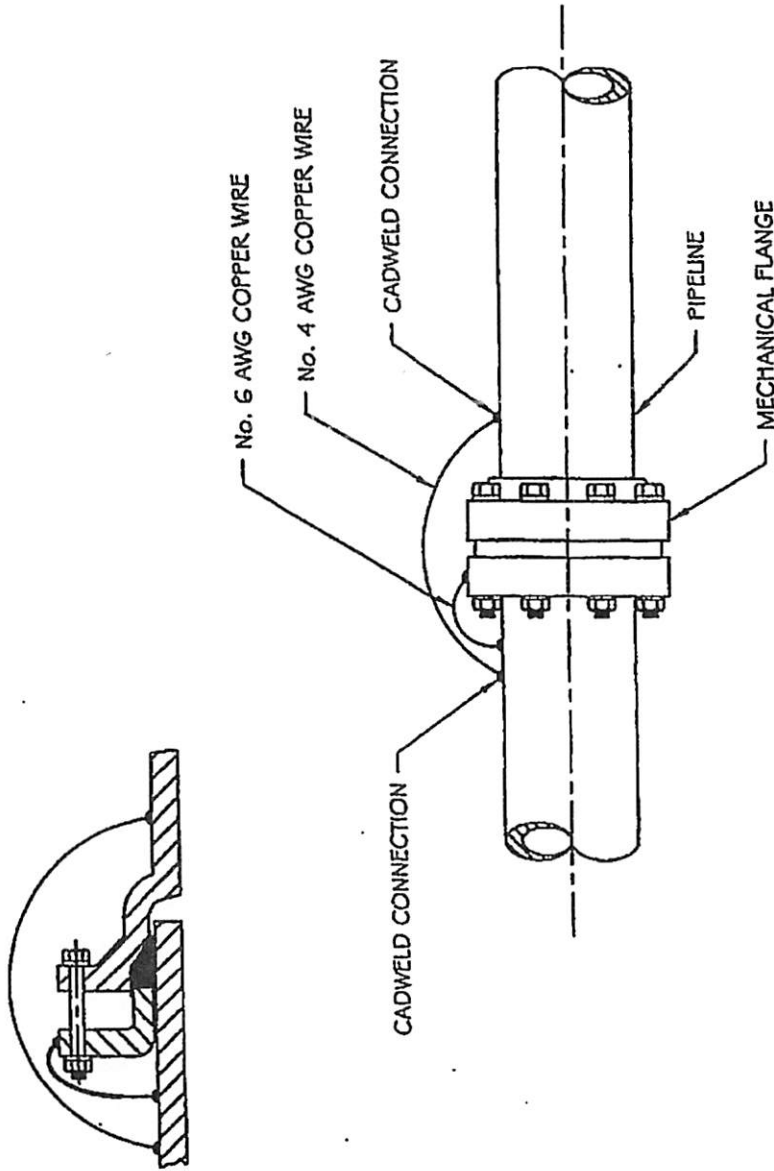

THIS DESIGN IS NOT APPLICABLE FOR USE AS STANDARD CORROSION CONTROL PROCEDURES FOR OTHER PROJECTS DUE TO VARIABLE CONDITIONS AT OTHER SITES. NEITHER THIS DESIGN NOR ANY PART THEREOF MAY BE DUPLICATED IN ANY WAY FOR OTHER PROJECTS, EXCEPT BY WRITTEN AGREEMENT WITH CORRPRO COMPANIES, INC.

CATHODIC PROTECTION SYSTEM  
TYPICAL METHOD  
OF BONDING ACROSS  
MECHANICAL FLANGE

DRAWN BY	S.M.T.
DESIGNED BY	
DATE	8-12-93
SCALE	NONE
SHEET	1 OF 1
DWG. No.	24124-T

REVISION

NO.	DATE	BY

**CORRPRO COMPANIES, INC.**  
1055 West Smith Road  
Medina, Ohio 44258  
(330) 723-5082



FIGURE #16

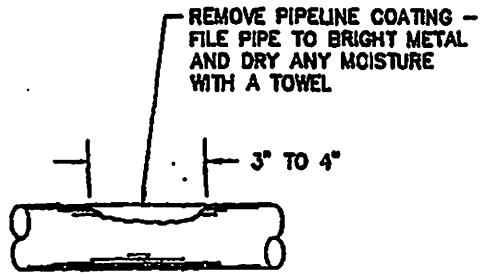

STEP 1

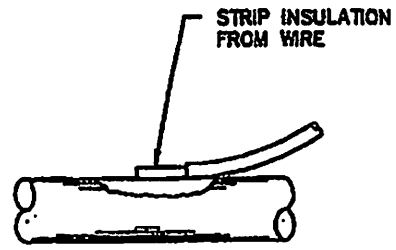

STEP 2\*\*

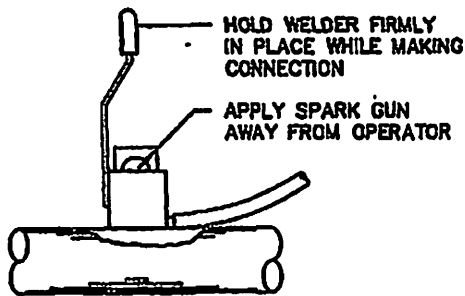

STEP 3

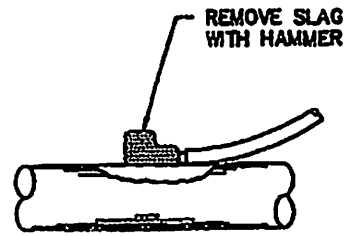

STEP 4

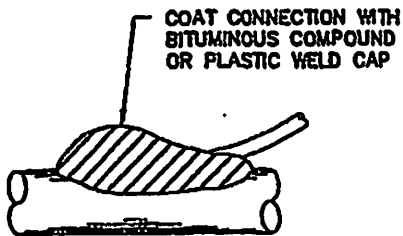

STEP 5

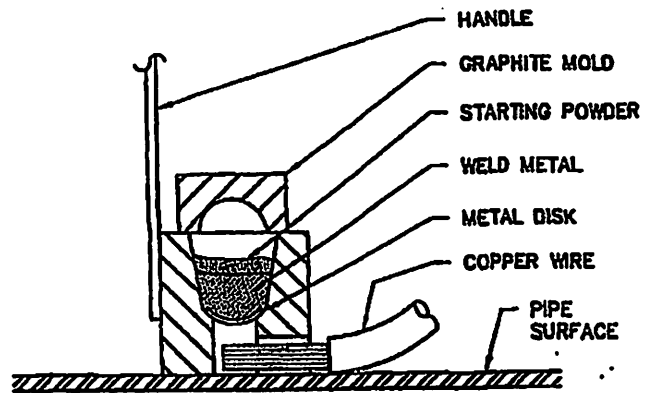

\*\* WHEN No. 14 To No. 10 AWG SOLID WIRE IS USED, IT WILL BE NECESSARY TO INSTALL A COPPER SLEEVE (CAB-133-1H) OVER THE BARE SECTION OF WIRE BEFORE THE CONNECTION IS ATTEMPTED. WIRE SHOULD PROTRUDE 1/8" BEYOND END OF SLEEVE.

THIS DESIGN DRAWING IS NOT APPLICABLE FOR USE AS STANDARD CORROSION CONTROL PROCEDURES FOR OTHER PROJECTS DUE TO VARIABLE CONDITIONS AT OTHER SITES. NEITHER THIS DESIGN NOR ANY PART THEREOF MAY BE DUPLICATED IN ANY WAY FOR OTHER PROJECTS, EXCEPT BY WRITTEN AGREEMENT WITH CORRPRO COMPANIES, INC.

NO.	DATE	BY	REVISION

DRAWN BY	A.M.S.
DESIGNED BY	
DATE	6-4-74
SCALE	NONE
SHEET	1 OF 2
DWG. No.	10634-T



**CORRPRO COMPANIES, INC.**  
 1055 West Smith Road  
 Medina, Ohio 44258  
 (330) 723-8082

**PROCEDURE FOR MAKING CADWELD TYPE "HA" CONNECTIONS**

**FIGURE #17**

**GENERAL WELDING PROCEDURE  
TYPE HA**

1. WHEN USING No. 14 To No. 10 AWG SOLID WIRE, IT WILL BE NECESSARY TO INSTALL A COPPER SLEEVE (CAB-133-1H) OVER THE BARE END OF THE WIRE AND CRIMP IN PLACE BEFORE ATTEMPTING TO MAKE THE CONNECTION. FOR No. 10 AWG STRANDED WIRE, USE CAB-133-1K. THE WIRE SHOULD PROTRUDE AT LEAST 1/8" FROM THE END OF THE SLEEVE.
2. INSERT THE CONDUCTOR INTO MOLD NOTING ANY SPECIAL INFORMATION UNDER "POSITIONING" FOR APPLICATION TYPE IN THE MANUFACTURERS INSTRUCTIONS PACKAGED WITH THE WELDER.
3. INSERT STEEL DISK IN BOTTOM OF CAVITY INSIDE MOLD. DUMP THE WELD METAL INTO MOLD BEING CAREFUL NOT TO UPSET THE STEEL DISK. TAP THE BOTTOM OF THE TUBE TO LOOSEN ALL THE STARTING POWDER AND SPREAD IT EVENLY OVER THE WELD METAL. PLACE A SMALL AMOUNT OF STARTING POWDER ON THE TOP EDGE OF MOLD UNDER COVER OPENING FOR EASY IGNITION.
4. CLOSE COVER AND IGNITE WITH THE FLINT GUN. MOVE FLINT GUN AWAY QUICKLY TO PREVENT FOULING. IF FLINT GUN SHOULD BECOME FOULED, SOAK IT IN HOUSEHOLD AMMONIA.
5. AFTER IGNITION, HOLD THE WELDER IN PLACE FOR A MOMENT TO ALLOW THE WELD TO SOLIDIFY. AFTER THE WELD HAS COOLED, REMOVE THE SLAG WITH A CHIPPING HAMMER OR WIRE BRUSH.
6. COAT THE CONNECTION AND THE ENTIRE PREPARED SURFACE WITH BITUMASTIC COMPOUND (KOPPERS No. 50 OR EQUAL) OR PLASTIC WELD CAPS.
7. REMOVE ALL SLAG FROM THE WELDER BEFORE MAKING THE NEXT WELD. CLEAN THE COVER EVERY 6 TO 10 WELDS.
8. WET OR DAMP MOLDS WILL PRODUCE POROUS WELDS. MOLDS MUST BE DRIED OUT BEFORE ATTEMPTING TO WELD.
9. CONNECTIONS ARE TO BE PLACED A MINIMUM OF 3 INCHES APART. UNSUCCESSFUL WELDS ARE TO BE ABANDONED AND MOVED TO ANOTHER PREPARED SURFACE NOT LESS THAN 3 INCHES AWAY.

NO.	DATE	BY	REVISION
 <b>CORRPRO COMPANIES, INC.</b> 1055 West Smith Road Medina, Ohio 44258 (330) 723-5082			DRAWN BY A.M.S. DESIGNED BY DATE 6-4-74 SCALE NONE SHEET 2 OF 2 DWG. No. 10634-T

**PROCEDURE FOR MAKING  
CADWELD TYPE "HA"  
CONNECTIONS**



**AMERICAN**  
FLOW CONTROL

**AMERICAN-DARLING 5-1/4" B-84-B-5 FIRE HYDRANT**

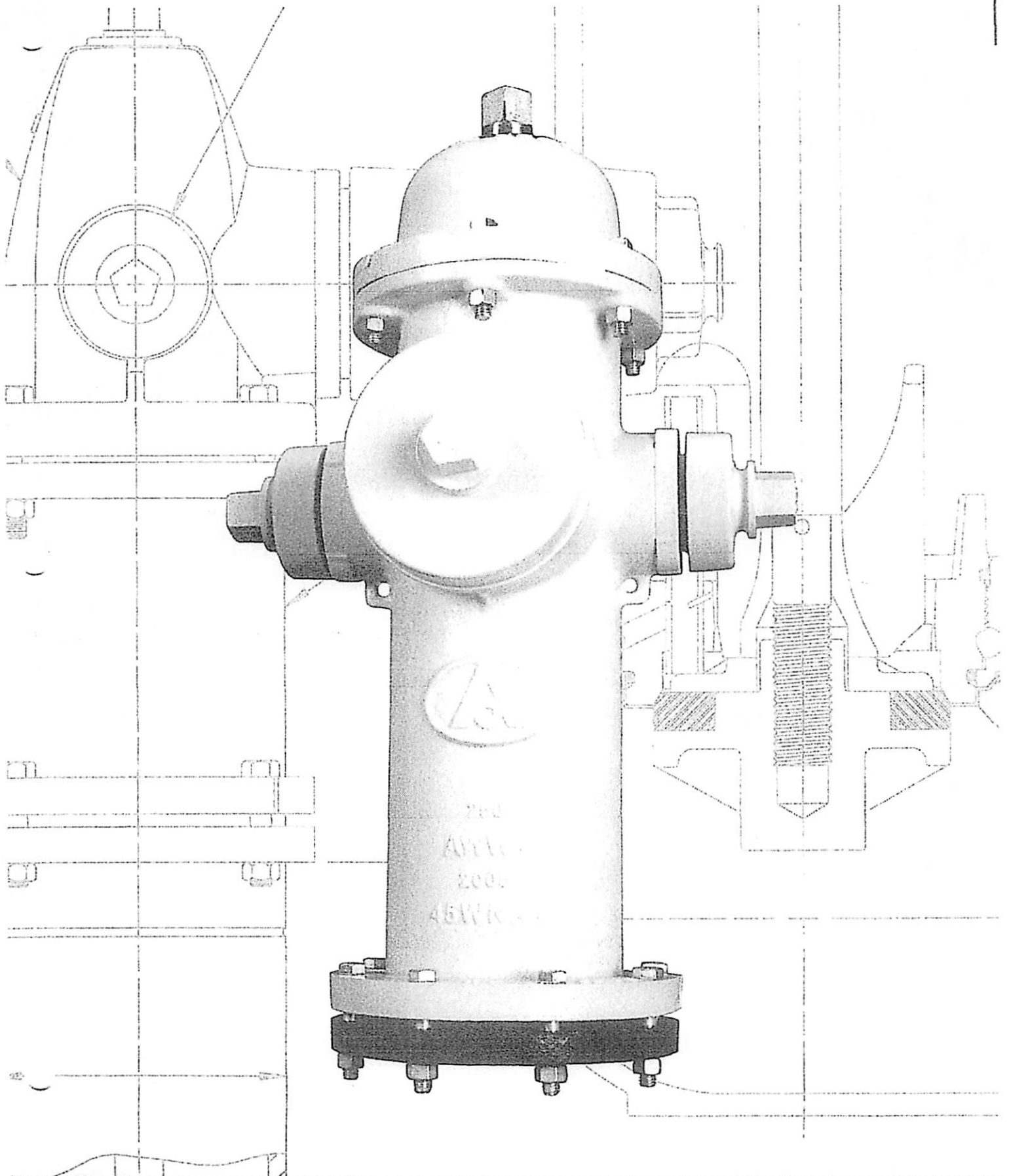





**AMERICAN**  
FLOW CONTROL

**2" - 12" SERIES 2500 RESILIENT WEDGE GATE VALVE**

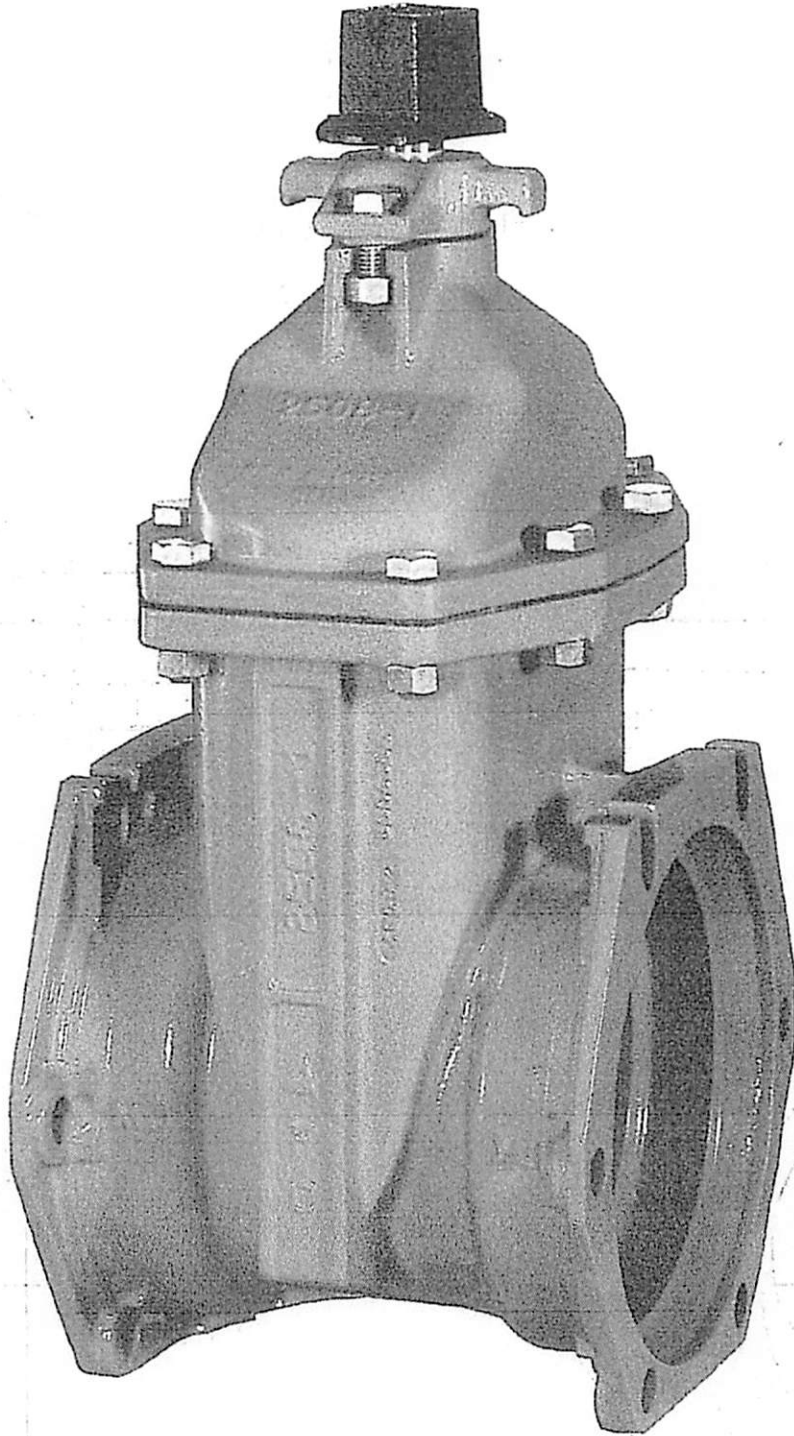



# AMERICAN

THE RIGHT WAY

SEAF

Home Products Valves and Hydrants Fire Hydrants 5 1/4" American-Darling B-84-B-5

## 5 1/4" American-Darling B-84-B-5



### Product Description

The American-Darling B-84-B-5 fire hydrant incorporates more than 100 years of experience in design, manufacture and field experience. This means dependable and efficient operation when needed.

Introduced in 1984, the B-84-B-5 fire hydrant is AWWA rated at 250 psig and is seat tested at 500 psig. This hydrant meets or exceeds all requirements of ANSI/AWWA C502 for dry-barrel hydrants.

The B-84-B-5 fire hydrant has all the features you expect from a high-quality fire hydrant. The all-bronze seat and bronze drain ring assure that the B-84-B-5 fire hydrant is easily repaired by just one person. The epoxy-primed and polyurethane top-coat system on the external surfaces on the upper barrel of the AMERICAN B-84-B-5 fire hydrant provides a durable, high-gloss finish that, under normal conditions, should continue to look good for years without repainting.

The B-84-B-5 fire hydrant has been manufactured for more than 30 years.

### UL Listed and FM Approved

The B-84-B-5 fire hydrant is UL Listed and Approved by FM Approvals in applicable configurations.

### Certified to NSF/ANSI 61 and NSF/ANSI 372

The B-84-B-5 fire hydrant is Certified as complying with NSF/ANSI Standard 61 and NSF/ANSI 372, which exhibit compliance with the U.S. Safe Drinking Water Act.

### Related Products

Storz Nozzles - Quarter Turn Pumper Connection

The AMERICAN Captivator™ - Locking Nozzle Cap

Series 2100 Hydrant Security Check Valve

# AMERICAN Flow Control Submittal Information

## 5-1/4 B84B-5 TRAFFIC MODEL FIRE HYDRANT

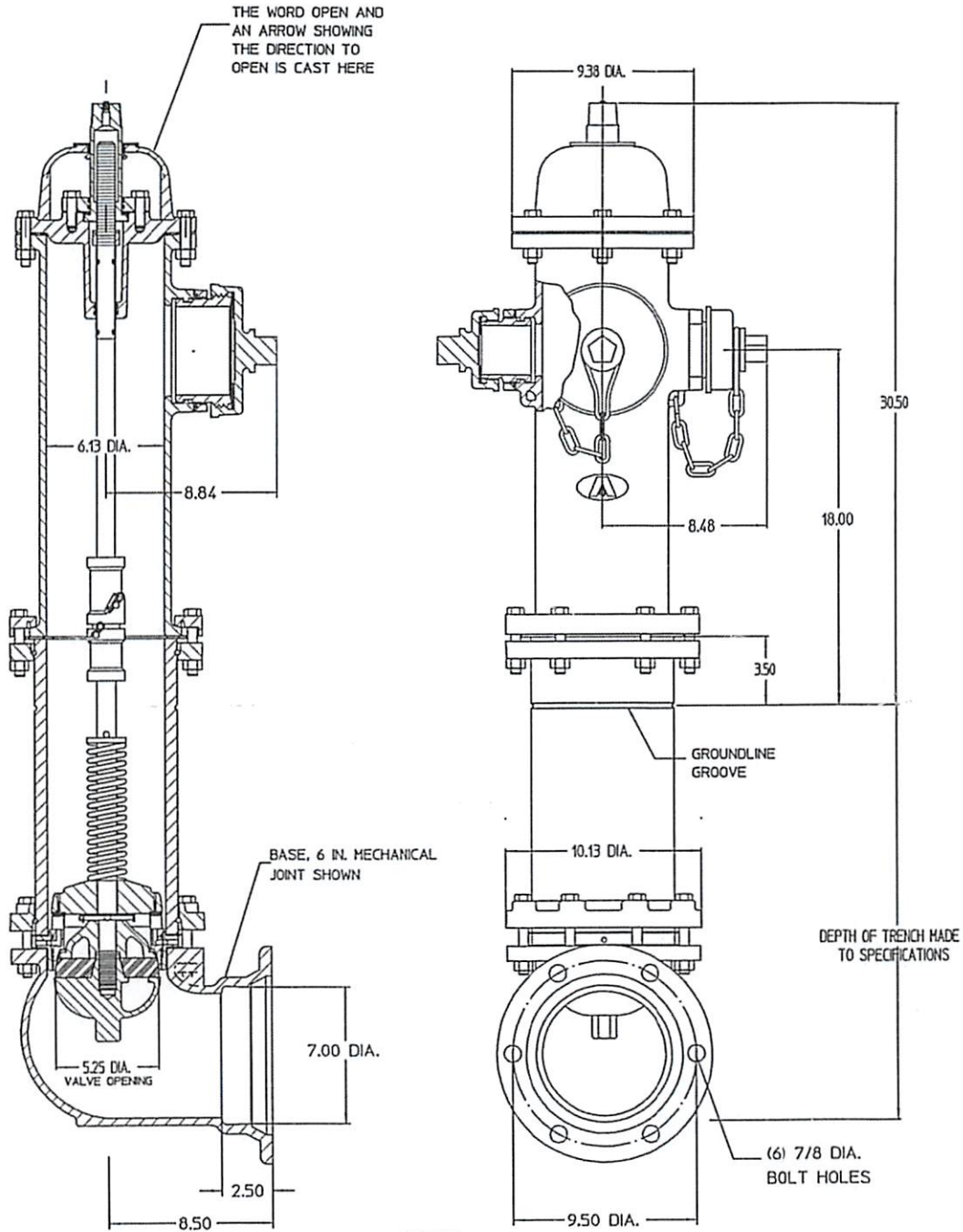

91-21441

**NOTES**

1. Size and shape of operating nut and nut on caps, threading on nozzles and caps and the direction of opening made to specifications.
2. Cap chains are not furnished unless specified.
3. Bolts and nuts are rustproof steel ASTM A307 or equivalent, in accordance with AWWA C502.
4. Working pressure 250 psig, test pressure 500 psig.
5. Hydrant conforms to AWWA standard C502.
6. UL Listed and Approved by FM Approvals at 200 psig in allowable configurations.
7. Valve top, valve bottom and base coated with fusion bonded epoxy coating.
8. Certified to NSF/ANSI Standard 61 and NSF/ANSI 372.
9. Nominal turns to open is 19-1/2.



**AMERICAN**  
FLOW CONTROL

THE RIGHT WAY

AMERICAN Flow Control  
P.O. Box 2727  
Birmingham, Al. 35202-2727  
Phone: 800-326-8051  
Fax: 800-610-3569  
Email: afcsales@american-usa.com

Waterous Company  
125 Hardman Avenue South  
South St. Paul, Mn. 55075-1191  
Phone: 888-266-3686  
Fax: 800-601-2809  
Email: afcsales@american-usa.com

[WWW.AMERICAN-USA.COM](http://WWW.AMERICAN-USA.COM)

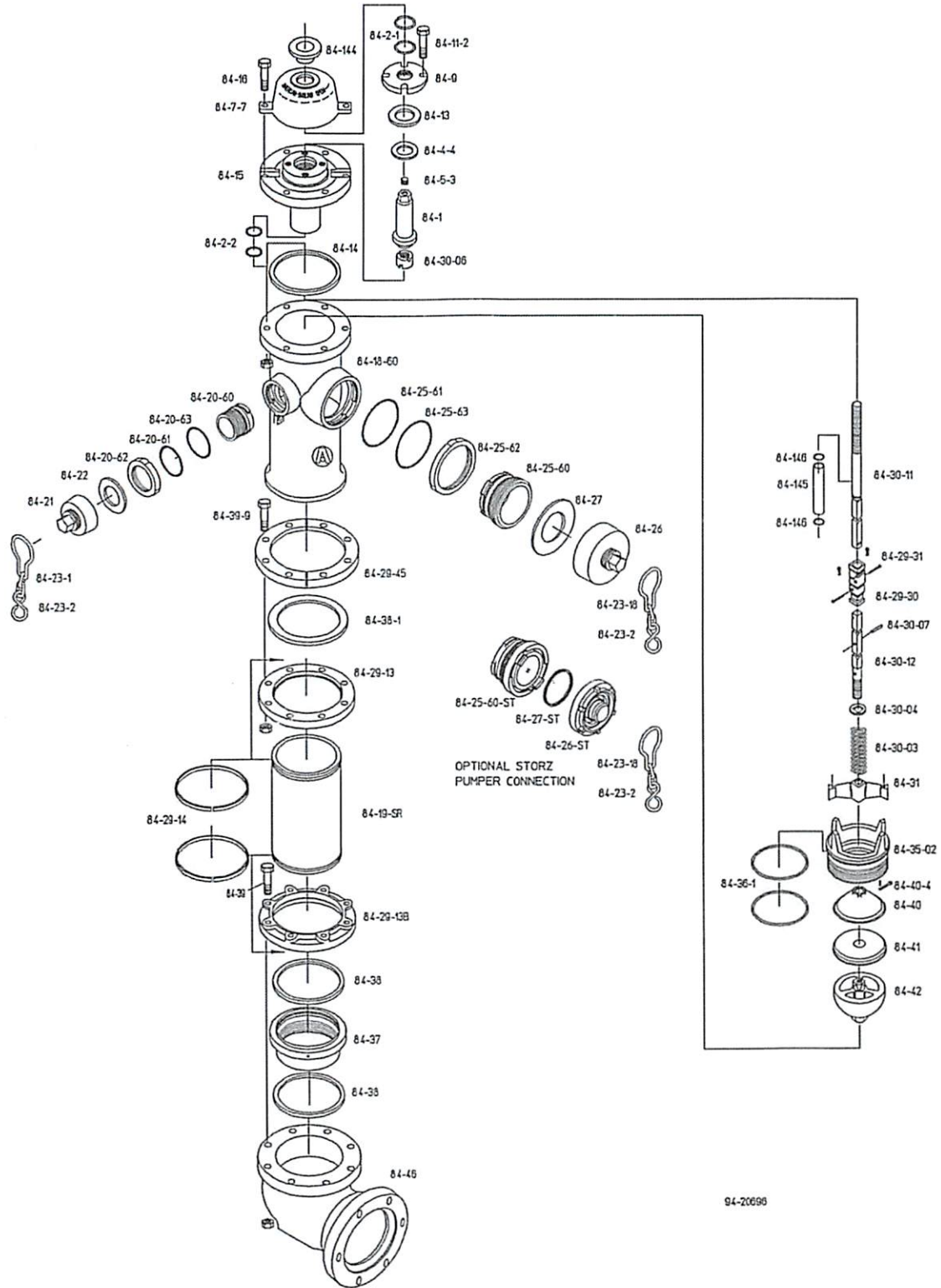

94-20696



**AMERICAN**  
FLOW CONTROL

THE RIGHT WAY

AMERICAN Flow Control  
P.O. Box 2727  
Birmingham, Al. 35202-2727  
Phone: 800-326-8051  
Fax: 800-510-3569  
Email: afcsales@american-usa.com

Waterous Company  
125 Hardman Avenue South  
South St. Paul, Mn. 55075-1191  
Phone: 888-266-3686  
Fax: 800-601-2809  
Email: afcsales@american-usa.com

[WWW.AMERICAN-USA.COM](http://WWW.AMERICAN-USA.COM)

Ref. No.	Qty.	Description	Material
84-1	1	Operating Nut	Bronze ASTM B763 UNS C86500
84-2-1	2	Cover O-Ring	Buna N
84-2-2	2	Housing O-Ring	Buna N
84-4-4	1	Thrust Washer	Nylatron
84-5-3	1	Pipe Plug	Stainless Steel
84-7-7	1	Weather Cover	Gray Iron ASTM A126 Class B
84-9	1	Housing Cover	Gray Iron ASTM A126 Class B
84-11-2	4	Cover Cap Screws	See Note 3
84-13	1	Cover Gasket	Fiber
84-14	1	Housing Gasket	EPDM Rubber
84-15	1	Housing	Ductile Iron ASTM A536 Grade 65-45-12
84-16	6	Housing Bolts & Nuts	See Note 3
84-18-60	1	Upper Barrel	Ductile Iron ASTM A536 Grade 65-45-12
84-19-SR	1	Lower Barrel	Ductile Iron ASTM A536 Grade 65-45-12
84-20-60	2	Hose Nozzle	Bronze ASTM B763 UNS C87600
84-20-61	2	Hose Nozzle Seal	Buna N
84-20-62	2	Hose Nozzle Retainer	Ductile Iron ASTM A536 Grade 65-45-12
84-20-63	2	Hose Nozzle Retainer Washer	Teflon
84-21	2	Hose Cap	*See Below
84-22	2	Hose Cap Gasket	Rubber
84-23-1	2	Hose Cap Chain with S-Hook	Steel
84-23-2	3	S-Hook	Steel
84-23-18	1	Pumper Cap Chain with S-Hook	Steel
84-25-60	1	Pumper Nozzle	Bronze ASTM B763 UNS C86700
84-25-60-ST	1	Storz Nozzle	Bronze/Aluminum
84-25-61	1	Pumper Nozzle Seal	Buna N
84-25-62	1	Pumper Nozzle Retainer	Ductile Iron ASTM A536 Grade 65-45-12
84-25-63	1	Pumper Nozzle Retainer Washer	Teflon
84-26	1	Pumper Cap	*See Below
84-26-ST	1	Storz Nozzle Cap	Aluminum
84-27	1	Pumper Cap Gasket	Rubber
84-27-ST	1	Storz Cap Gasket	Rubber
84-29-13	1	Barrel Flange	Ductile Iron ASTM A536 Grade 65-45-12
84-29-13B	1	Base Flange	Ductile Iron ASTM A536 Grade 65-45-12
84-29-14	2	Snap Ring	Stainless Steel

\*National Standard and other common cap configurations are constructed of ASTM A536 Grade 65-45-12 ductile iron. Other offerings may be constructed of ASTM A126 Class B gray cast iron.

Ref. No.	Qty.	Description	Material
84-29-30	1	Rod Coupling	Gray Iron ASTM A126 Class B
84-29-31	2	Rod Coupling Pin & Clip Pin	Stainless Steel
84-29-45	1	Breakable Flange	Gray Iron ASTM A126 Class B
84-30-03	1	Hydrant Spring	Stainless Steel
84-30-04	1	Spring Plate	Stainless Steel
84-30-06	1	Travel Stop Nut	Bronze ASTM B283 UNS C37700
84-30-07	1	Spring Plate Pin	Stainless Steel
84-30-11	1	Upper Rod	Steel
84-30-12	1	Lower Rod	Steel
84-31	1	Drain Lever	Bronze ASTM B584 UNS C92200
84-35-02	1	Hydrant Seat	Bronze ASTM B584 UNS C92200
84-36-1	2	Seat O-Ring	Buna N
84-37	1	Drain Ring	Bronze ASTM B763 UNS C87600
84-38	2	Drain Ring Gasket	Composition Rubber
84-38-1	1	Barrel Gasket	Composition Rubber
84-39	8	Base Bolts & Nuts	0304 Stainless Steel
84-39-9	8	Barrel Bolts & Nuts	See Note 3
84-40	1	Valve Top	Gray Iron ASTM A126 Class B
84-40-4	1	Valve Top Clevis & Clip Pin	Stainless Steel
84-41	1	Hydrant Valve	EPDM Rubber
84-42	1	Valve Bottom	Ductile Iron ASTM A536 Grade 65-45-12
84-46-2	1	Flanged Base	Ductile Iron ASTM A536 Grade 65-45-12
84-46-2A	1	Flanged Vertical Entry Base	Ductile Iron ASTM A536 Grade 65-45-12
84-46-5	1	Mechanical Joint Base	Ductile Iron ASTM A536 Grade 65-45-12
84-46-PE	1	Mechanical Joint Plain End Base	Ductile Iron ASTM A536 Grade 65-45-12
84-46-TY	1	Tyton Base	Ductile Iron ASTM A536 Grade 65-45-12
84-144	1	Weather Shield	Rubber
84-145	1	Rod Sleeve	Bronze
84-146	2	Rod Sleeve O-Ring	Buna N

Hydrants are furnished as "Draining" unless optional "Non-Draining" Configuration is otherwise noted below.

Optional "Non-Draining" Configuration required

Open Direction  Left(C.C.W.)  Right(C.W.)



**AMERICAN**  
FLOW CONTROL

THE RIGHT WAY

AMERICAN Flow Control  
P.O. Box 2727  
Birmingham, AL 35202-2727  
Phone: 800-326-8051  
Fax: 800-610-3569  
Email: afcsales@american-usa.com

Waterous Company  
125 Hardman Avenue South  
South St. Paul, Mn. 55075-1191  
Phone: 888-266-3686  
Fax: 800-601-2809  
Email: afcsales@american-usa.com

WWW.AMERICAN-USA.COM

Available Bases

SIZE	HM	JM	KM	LM	HOLES	
					NO.	SIZE
4	8.50	2.50	4.91	7.50	4	7/8
6	8.50	2.50	7.03	9.50	6	7/8
8	10.25	2.50	9.18	11.75	6	7/8

MECHANICAL JOINT BASE

6" TYTON BASE WITH LUGS

SIZE	A	B	C	D	HOLES	
					NO.	SIZE
4	8.00	9.00	0.94	7.50	8	3/4
6	8.50	11.00	1.00	9.50	8	7/8

FLANGED BASE

6" PLAIN END W/INTEGRAL MJ GLAND BASE

IL1473-2

AVAILABLE NOZZLE ARRANGEMENTS

2 HOSE  
1 PUMPER

2 HOSE  
90 DEGREES  
APART

91-21951

6" FLANGED VERTICAL ENTRY BASE



**AMERICAN**  
FLOW CONTROL

THE RIGHT WAY

AMERICAN Flow Control  
P.O. Box 2727  
Birmingham, Al. 35202-2727  
Phone: 800-326-8051  
Fax: 800-510-3569  
Email: afcsales@american-usa.com

Waterous Company  
125 Hardman Avenue South  
South St. Paul, Mn. 55075-1191  
Phone: 888-266-3686  
Fax: 800-601-2809  
Email: afcsales@american-usa.com

WWW.AMERICAN-USA.COM



[Home](#) [Products](#) [Valves and Hydrants](#) [14"-66" Series 2500 RW Gate Valves](#) [14"-24" Resilient Wedge Gate Valves with Flanged Ends](#)

## 14"-24" Resilient Wedge Gate Valves with Flanged Ends

Valves 14"-24" shall be resilient wedge gate valves, of a non-rising stem design and rated for 250 psig cold water working pressure. All cast ferrous components shall be ductile iron, ASTM A536. Valves 14"-24" shall meet or exceed all applicable requirements of AWWA C515. The words "Ductile Iron" or "D.I." shall be cast on the valve. The wedge shall be ductile iron fully encapsulated with EPDM rubber.

The wedge shall be symmetrical and seal equally well with flow in either direction. The wedge nut shall be independent of the wedge and held in place on three sides by the wedge to prevent possible misalignment. Valves shall be Certified to NSF 61-G.

Bolting materials shall be 304 stainless steel unless otherwise specified. Bolts may have either regular square or hexagonal shaped heads with dimensions conforming to ANSI B18.2.1. Metric size socket head cap screws are not allowed. The operating nut shall be constructed of ductile iron. All gaskets shall be pressure-energized O-Ring type seals. Stem shall be sealed by three O-Rings. O-Rings set in a cartridge shall not be allowed. The valve shall have thrust washers located with (1) above and (1) below the thrust collar to assist operation of the valve. All internal and external surfaces of the valve body and bonnet shall have an epoxy coating, complying with ANSI/AWWA C550.

Valves shall be AMERICAN's Series 2500 resilient wedge gate valve.

© 2015 AMERICAN (American Cast Iron Pipe Company). All rights reserved.

# The Meter Setter



## A Plastic Lid Rated to 40,000 Pounds!

Ford offers coil pit lids with an H-20 rating.



For heavy duty lid applications that require low AMR signal interference, Ford offers two new coil pit lids. With an H-20 rating meeting 40,000 pound proof load for traffic requirements, these lids for 15" and 18" tile are durable and UV resistant.

Ford lids are tested in accord with the American Association of State Highway and Transportation Officials (AASHTO) M306 protocols to ensure standardized load rating and acceptance criteria.

Some H-20 rated lids are tested to different standards or outdated specifications that may not hold up to the AASHTO M306 protocols. Ford lids are engineered to achieve the rigorous standards of these protocols, providing our customers with the quality they have come to expect.

In addition to being UV resistant and offering an optional AMR bracket, the new lids also feature a pentagon bolt and the same Clark Style Worm Lock used in standard coil pit lids, making change outs with existing pits seamless.

For information on the H-20 rated coil pit lid, or any of the other H-20 lids offered by Ford Meter Box, contact your local Ford distributor or your Ford Meter Box Customer Manager.



**The Ford Meter Box Co., Inc.** 775 Manchester Avenue, P.O. Box 443, Wabash, Indiana, USA 46992-0443  
Telephone: 260-563-3171 FAX: 1-800-826-3487 Overseas FAX: 260-563-0167 [www.fordmeterbox.com](http://www.fordmeterbox.com)



# SUBMITTAL INFORMATION

## Iron Lid for Iron Frame - (C3L-C-REC-T style)

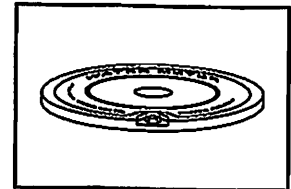

11-1/2" OVERLAPPING LID WITH CENTER RECESS HOLE

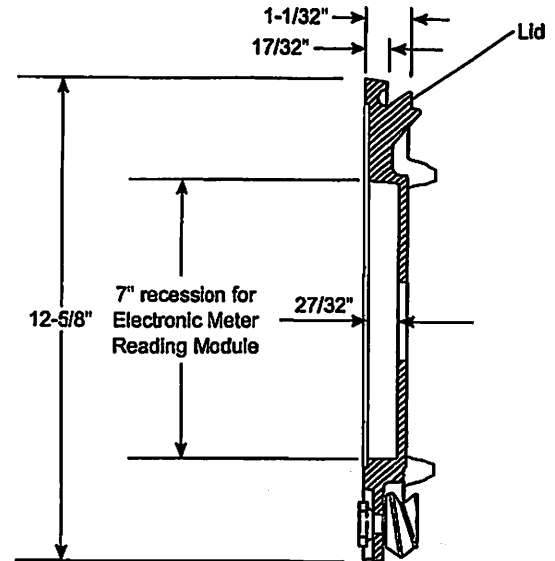
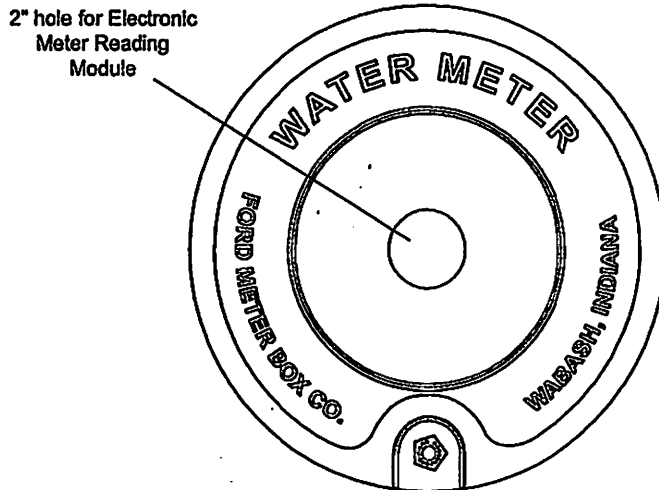

*LID SIZE	APPROX. WT. LBS.	DESCRIPTION	CATALOG NUMBER	✓ SUBMITTED ITEM(S)
11-1/2"	11.4	Locking Overlapping Lid Single centered and recessed hole for Meter Reading Module	C3L-C-REC-T	

\* Lid size indicates approximate pit access opening; actual lid diameter is approximately 1" larger.

### FEATURES

- Standard pentagon bolt furnished with locking lids
- Lid is cast iron per ASTM A48, Class 25
- Recessed lid offers ideal location for large electronic meter reading module
- Finish is black e-coat epoxy coating

**Optional Large Bolt** for locking lid. Add "-LB" to end of catalog number

The Ford Meter Box Company considers the information in this submittal form to be correct at the time of publication. Item and option availability, including specifications, are subject to change without notice. Please verify that your product information is current.



**The Ford Meter Box Company, Inc.**  
 P.O. Box 443, Wabash, Indiana U.S.A. 46992-0443  
 Phone: 260-563-3171 / Fax: 800-826-3487  
 Overseas Fax: 260-563-0167  
 www.fordmeterbox.com

09/16/14

Submitted By:

## ADS METER PIT SPECIFICATION

### Scope

This specification describes 18-, 21-, and 24-inch (450, 525, and 600mm) Meter Pit for use as meter enclosures.

### Requirements

ADS Meter Pits shall be white in color. Meter pits shall have a smooth interior and annular exterior corrugations. Based on ASTM D 2412 at 5% deflection the pipe stiffness for 18-inch (450 mm), 21-inch (525 mm), and 24-inch (600 mm) Meter Pits shall be 40 pii (275 N/m/mm), 34 pii (235 N/m/mm), and 34 pii (235 N/m/mm), respectively. The pits shall be available in 24, 30, 36, 48 inch, and 12 foot (0.6, 0.8, 0.9, 1.2, and 3.7 m) lengths. Meter Pits shall be notched at 0 and 180 degrees at the base to accommodate inlet and outlet pipes.

### Material Properties

Meter pits shall be high density polyethylene conforming with the minimum requirements of cell classification 424420 B as defined and described in the latest version of ASTM D3350.

### Installation

Installation shall be in accordance with ADS installation instructions or those issued by regional, state, or local agencies.

### Nominal Dimensions

Inner Diameter	in (mm)	18 (450)	21 (525)	24 (600)
Outer Diameter	in (mm)	21.5 (546)	25 (635)	28.4 (721)

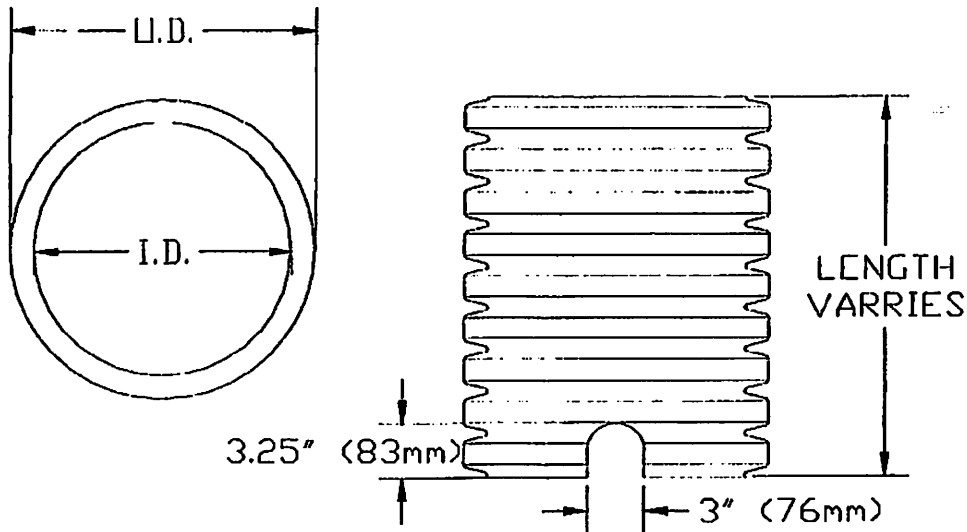

**Warning:** This product is not supplied with a grate or lid for means of termination at the ground surface. It is the sole responsibility of the installer/user of this product to adequately insure the product has been covered and secured at the top of the structure/product. Poor installation or failure to adequately cover and secure this product may result in injury to persons and property.

# iPERL™ Water Management System

## Specifications

### TYPE

Solid state, battery operated electromagnetic flow measurement system with a hermetically sealed, glass covered, electronic register with a programmable 9-digit display.

### CONFORMANCE TO STANDARDS

Must conform to American Water Works Standard C-700 and C-710 as most recently revised with respect to accuracy and pressure loss requirements, or other appropriate American Water Works Standard. Must be compliant with NSF/ANSI Standard 61 Annex F and G.

### REGISTER

The register must be an electronic device encapsulated in glass with 9 programmable digits utilizing a liquid crystal display (LCD). It will have indicators for flow direction, empty pipe, battery life and unit of measurement. The register must be hermetically sealed with a heat tempered glass cover and be tamperresistant. The register shall not be removable from the measuring sensor. The register shall utilize a magnetic coupling technology to connect to a touch read, radio read or fixed base meter reading system in either an inside or pit set installation.

### MEASURING ELEMENT

The measuring element shall be made of a noncorrosive, lead-free glass fiber reinforced, composite alloy material. A battery powered magnetic flow sensor utilizing silver/silver chloride electrodes will be utilized to measure the velocity of the water which is linearly proportional to the volume. The measuring element will have no moving parts and will be specific for each size.

### EXTERNAL HOUSING

The register and measuring element will be an integrated unit housed within a thermal plastic external casing. This integrated unit will not be removable from the external housing. The systems shall have the size and direction of water flow through the system imprinted on the external housing.

### PRESSURE CAPABILITY

System shall operate up to a working pressure of 200 pounds per square inch (psi), without leakage or damage to any parts. The accuracy shall not be affected by variation of pressure up to 200 psi.

### PERFORMANCE WARRANTIES

In evaluating bid submittals, warranty coverage will be considered. All bidders are required to submit their most current nationally published warranty statements for water meter maincases, registers and measuring chambers.

### OPERATING CHARACTERISTICS

METER SIZE	LOW FLOW (95% Min)	OPERATING RANGE (98.5%-101.5%)	PRESSURE LOSS (Not to Exceed)
5/8"	0.03gpm	0.11 to 25gpm	4psi @ 15gpm
5/8" x 3/4"	0.03gpm	0.11 to 35gpm	2psi @ 15gpm
3/4" S	0.03gpm	0.11 to 35gpm	2psi @ 15gpm
3/4"	0.03gpm	0.11 to 35gpm	2psi @ 15gpm
1"	0.11gpm	0.4 to 55gpm	2psi @ 25gpm

© All products purchased and services performed are subject to Sensus' terms of sale, available at either: <http://na.sensus.com/TC/TermsConditions.pdf> or 1-800-METER-IT. Sensus reserves the right to modify these terms and conditions in its own discretion without notice to the customer.

This document is for informational purposes only, and SENSUS MAKES NO EXPRESS WARRANTIES IN THIS DOCUMENT. FURTHERMORE, THERE ARE NO IMPLIED WARRANTIES, INCLUDING WITHOUT LIMITATION, WARRANTIES AS TO FITNESS FOR A PARTICULAR PURPOSE AND MERCHANTABILITY. ANY USE OF THE PRODUCTS THAT IS NOT SPECIFICALLY PERMITTED HEREIN IS PROHIBITED.

# iPERL™ Water Management System

## Electromagnetic Flow Measurement System

## Description

5/8" (DN 15mm), 3/4" (DN 20mm) and 1" (DN 25mm) Sizes

With no moving parts, the Sensus iPERL water management system is based on innovative electromagnetic flow measurement technology. The iPERL system family has an operating range of 0.03 gpm (0.007 m<sup>3</sup>/hr) @ 95% minimum to 55 gpm (12.5 m<sup>3</sup>/hr) @ 100% ± 1.5% registration of actual throughput.

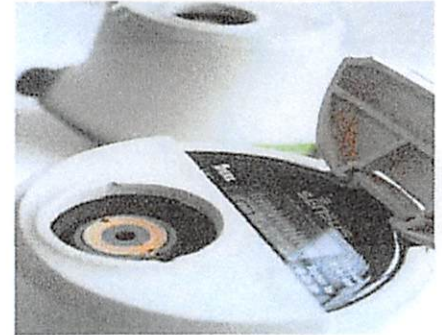

Electronic Register LCD Display

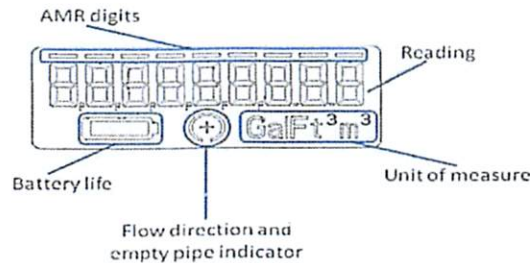

## Features

### CONFORMANCE TO STANDARDS

The iPERL system far exceeds the most recent revision of ANSI/AWWA Standard C-700 and C-710 for accuracy and pressure loss requirements. All iPERL systems are NSF/ANSI Standard 61 Annex F and G compliant and tested to AWWA standards.

### PERFORMANCE

The patented measurement technology of the iPERL system allows enhanced accuracy ranges at both low and high flows and perpetual accuracy over the life of the product over the full measurement range when installed horizontal, vertical or diagonal.

### CONSTRUCTION

The iPERL system is an integrated unit that incorporates an electronic register and measuring device encased in an external housing. The measuring device is comprised of a composite alloy flowtube with externally-threaded spud

ends. Embedded in the flowtube are magnetic flow sensors. The all electronic, programmable register is hermetically sealed with a tempered glass cover. The iPERL system has a 20 year life cycle, along with a 20 year battery life guarantee.

### ELECTRONIC REGISTER

The high resolution 9-digit hermetically sealed electronic register with LCD display was designed to eliminate dirt, lens fogging issues and moisture contamination in pit settings with built in tamper protection. The tempered glass register cover displays readings with the AMR digits highlighted. Direction of flow and units of measure are also easily readable on the register display. The iPERL register features; AMR resolution and unit of measure that are fully programmable, integral customer data logging compatible with UniPro software tools. The large, easy to read display also includes battery life, empty pipe and forward/reverse flow indicators.

### TAMPERPROOF FEATURES

The integrated construction of the iPERL system prevents removal of the register to obtain free water. The magnetic tamper and low field alarms will both indicate any attempt to tamper with the magnetic field of the iPERL system.

### AMR / AMI SYSTEMS

iPERL systems are compatible with current Sensus AMR/AMI systems.

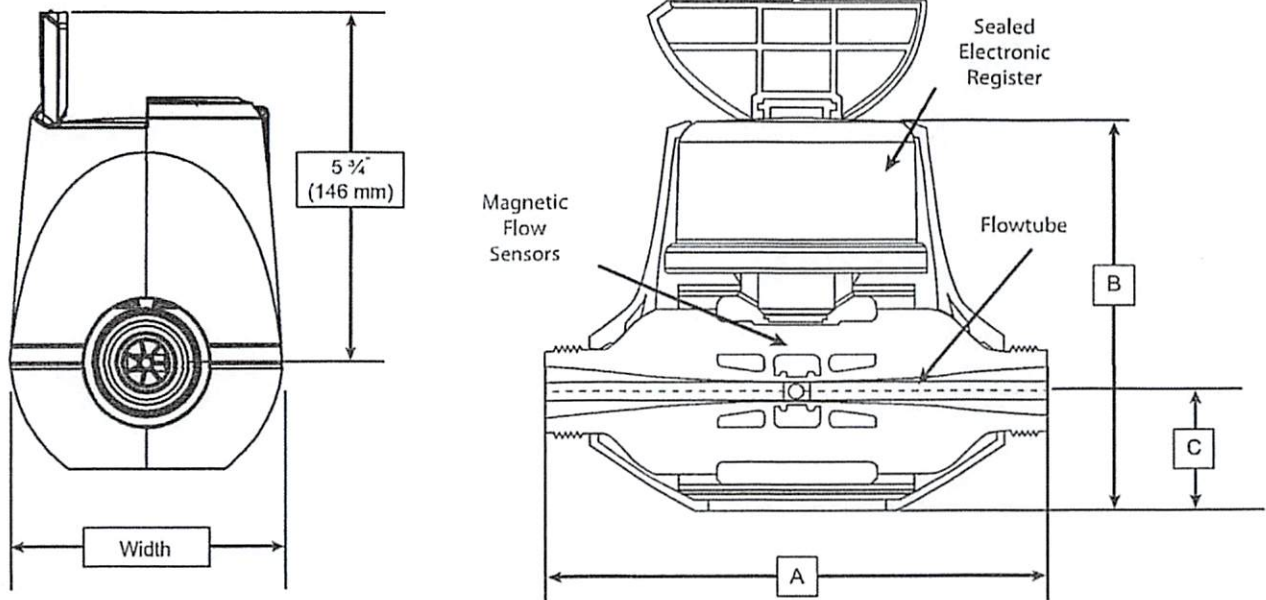

**DIMENSIONS AND NET WEIGHTS**

Size	A (lay length)	B	C	Spud Ends	NPSM Thread Size	Width	Net Weight
5/8" (DN 15 mm)	7-1/2" (190 mm)	6-1/10" (155 mm)	1-3/4" (44 mm)	5/8" (15 mm)	3/4" (19 mm)	4-1/2" (114 mm)	3.1 lb. (1.4 kg)
3/4"S (5/8" x 3/4") (DN 20 mm)	7-1/2" (190 mm)	6-1/10" (155 mm)	1-3/4" (44 mm)	3/4" (20 mm)	1" (25 mm)	4-1/2" (114 mm)	3.1 lb. (1.4 kg)
3/4" (DN 20 mm)	9" (229 mm)	6-1/10" (155 mm)	1-3/4" (44 mm)	3/4" (20 mm)	1" (25 mm)	4-1/2" (114 mm)	3.2 lb. (1.5 kg)
1" (DN 25 mm)	10-3/4" (273 mm)	6-1/10" (155 mm)	1-3/4" (44 mm)	1" (25 mm)	1-1/4" (32 mm)	4-1/2" (114 mm)	3.3 lb. (1.6 kg)

**SPECIFICATIONS**

<b>SERVICE</b>	Measurement of potable and reclaim water. Operating temperature range of 33 °F (0.56 °C) - 150 °F (65.6 °C)
<b>NORMAL OPERATING FLOW RANGE</b> (100% ±1.5%)	5/8" (DN 15mm) size: 0.11 to 25 gpm (0.02 to 5.7 m <sup>3</sup> /hr) 3/4" (DN 20mm) size: 0.11 to 35 gpm (0.02 to 8.0 m <sup>3</sup> /hr) 1" (DN 25mm) size: 0.4 to 55 gpm (0.09 to 12.5 m <sup>3</sup> /hr)
<b>LOW FLOW REGISTRATION</b> (95% - 101.5%)	5/8" (DN 15mm) size: 0.03 gpm (0.007 m <sup>3</sup> /h) 3/4" (DN 20mm) size: 0.03 gpm (0.007 m <sup>3</sup> /h) 1" (DN 25mm) size: 0.11 gpm (0.025 m <sup>3</sup> /h)
<b>MAXIMUM PRESSURE LOSS</b>	5/8" (DN 15mm) size: 4 psi at 15 gpm (0.3 bar at 3.4 m <sup>3</sup> /h) 3/4" (DN 20mm) size: 2 psi at 15 gpm (0.1 bar at 3.4 m <sup>3</sup> /h) 1" (DN 25mm) size: 2 psi at 25 gpm (0.1 bar at 5.7 m <sup>3</sup> /h)
<b>MAXIMUM OPERATING PRESSURE</b>	200 psi (13.8 bar)
<b>MEASUREMENT TECHNOLOGY</b>	Solid state electromagnetic flow

<b>REGISTER</b>	Hermetically sealed, 9-digit programmable electronic register AMR/AMI compatible iPERL system register programmable using the UniPro programming package
<b>MATERIALS</b>	External housing – Thermal plastic Flowtube – Polyphenylene sulfide alloy Electrode – Silver/silver chloride Register cover – Tempered glass
<b>ALARM DEFAULTS</b>	Alarm Duration – 90 days Leak Duration – 24 hours Datalog Interval – 1 hour Alarm Mask – All alarms reported History Mask – All event types reported



## HEADLOSS CURVES

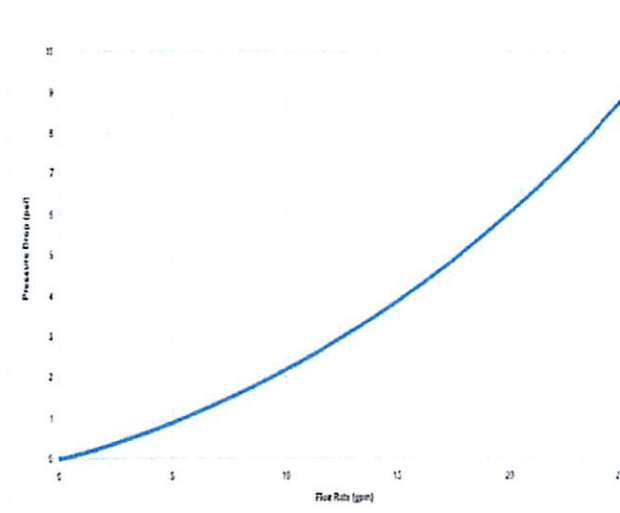

5/8" Headloss Curve

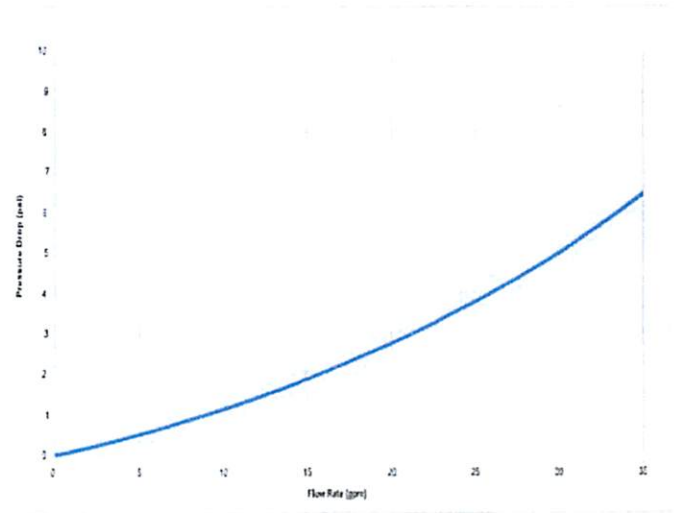

3/4" Short Headloss Curve

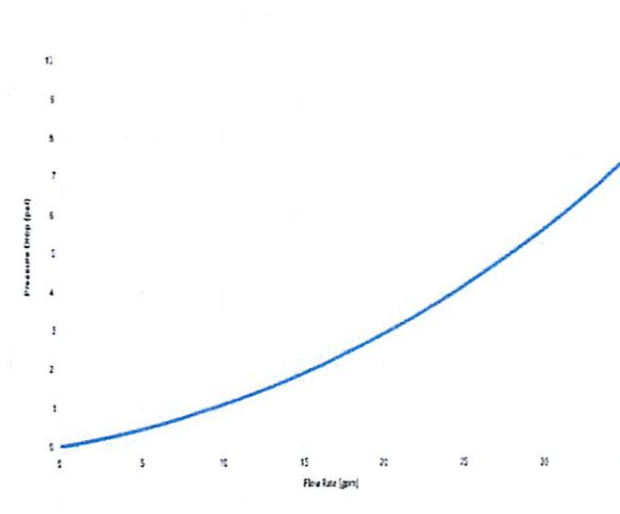

3/4" Headloss Curve

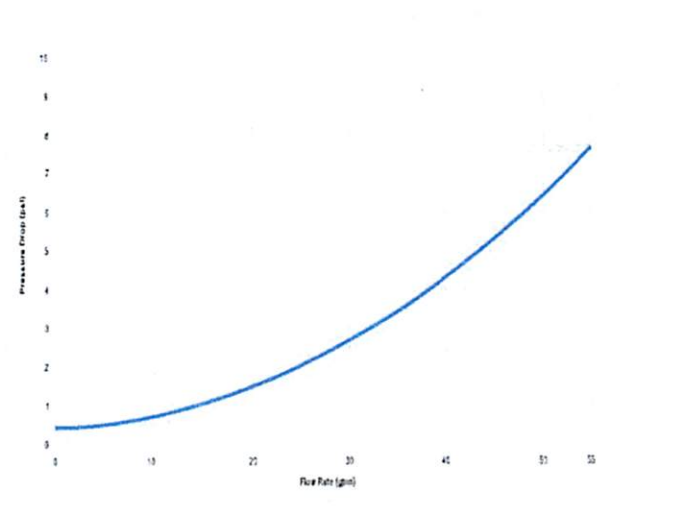

1" Headloss Curve

© All products purchased and services performed are subject to Sensus' terms of sale, available at either: <http://na.sensus.com/TC/TermsConditions.pdf> or 1-800-METER-IT. Sensus reserves the right to modify these terms and conditions in its own discretion without notice to the customer.

This document is for informational purposes only, and SENSUS MAKES NO EXPRESS WARRANTIES IN THIS DOCUMENT. FURTHERMORE, THERE ARE NO IMPLIED WARRANTIES, INCLUDING WITHOUT LIMITATION, WARRANTIES AS TO FITNESS FOR A PARTICULAR PURPOSE AND MERCHANTABILITY. ANY USE OF THE PRODUCTS THAT IS NOT SPECIFICALLY PERMITTED HEREIN IS PROHIBITED.

**OMNI™ C<sup>2</sup>**1-1/2", 2", 3", 4", 6", 8" and 10" OMNI C<sup>2</sup> Meter**Description****1-1/2", 2", 3", 4", 6", 8" and 10" Sizes**

The OMNI C<sup>2</sup> meter operation is based on advanced Floating Ball Technology (FBT).

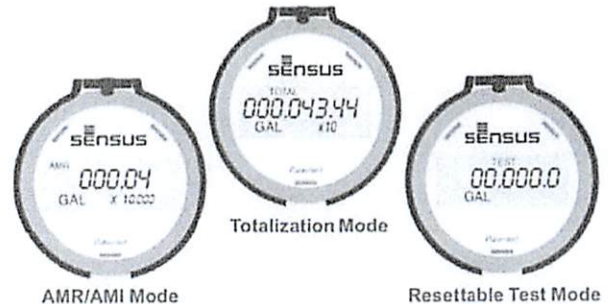
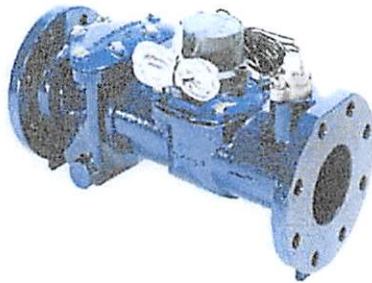
**Features****CONFORMANCE TO STANDARDS**

The OMNI C<sup>2</sup> meter meets and far exceeds the most recent revision of AWWA Standard C701 and C702 class II. Additionally, the meter does not require a valve to meet these standards. Each meter is performance tested to ensure compliance. All OMNI meters are NSF/ANSI Standard 61, Annex F and G approved latest standards.

**PERFORMANCE**

The patented measurement principles of the OMNI C<sup>2</sup> meter assure enhanced accuracy ranges, an overall greater accuracy, and a longer service life than any other comparable class meter produced. The OMNI C<sup>2</sup> meter has no restrictions as to sustained flow rates within its continuous operating range. The floating ball measurement technology allows for flows up to its rated maximum capacity without undue wear or accuracy degradation when installed in any orientation.

**CONSTRUCTION**

The OMNI C<sup>2</sup> meter consists of two basic assemblies; the maincase and the measuring chamber. The measuring chamber assembly includes the "floating ball" impeller with a coated titanium shaft, hybrid axial bearings, integral flow straightener and an all electronic programmable register with protective bonnet. The maincase is made from industry proven Ductile Iron with an approved NSF epoxy coating. Maincase features are; easily removable measuring chamber, unique chamber seal to the

maincase using a high pressure o-ring, testing port and an AWWA compliant strainer.

**OMNI ELECTRONIC REGISTER**

The OMNI C<sup>2</sup> electronic register is hermetically sealed with an electronic pickup containing no mechanical gearing. The large character LCD displays AMR, Totalization and a Resettable Test Totalizer. OMNI register features; AMR resolution units that are fully programmable, Pulse output frequency that are fully programmable, Integral customer data logging capability, Integral resettable accuracy testing feature compatible with UniPro Testing Assistant Program, Large, easy-to-read LCD also displays both forward and reverse flow directions and all with a 10-year battery life guarantee.

**MAGNETIC DRIVE**

Meter registration is achieved by utilizing a fully magnetic pickup system. This is accomplished by the magnetic actions of the embedded rotor magnets and the ultra sensitive register pickup probe. The only moving component in water is the "floating ball" impeller.

**MEASURING ELEMENT**

The revolutionary thermoplastic, hydro-dynamically balanced impeller floats between the bearings. The Floating Ball Technology (FBT) allows the measuring element to operate virtually without friction or wear, thus creating the extended upper and lower flow ranges capable on only the OMNI C<sup>2</sup> meter.

**STRAINER**

The OMNI C<sup>2</sup> with the AWWA compliant "V" shaped strainer using a stainless steel screen along with Floating Ball Technology (FBT) create a design that gives far improved accuracy even in those once thought questionable settings. A removable strainer cover permits easy access to the screen for routine maintenance.

**MAINTENANCE**

The OMNI C<sup>2</sup> meter is designed for easy maintenance. Should any maintenance be required, the measuring chamber and / or strainer cover can be removed independently. Parts and or a replacement measuring chamber may be utilized in the event repairs are needed. Replacement Measuring Chambers are available for the OMNI C<sup>2</sup> meters and may also be utilized for retrofitting to competitive meters to achieve increased accuracy and extended service life.

**AMR / AMI SYSTEMS:**

Meters and encoders are compatible with current Sensus AMR/AMI systems.

**GUARANTEE:**

Sensus OMNI C<sup>2</sup> Meters are backed by "The Sensus Guarantee." Ask your Sensus representative for details or see Bulletin G-500.

## OMNI C<sup>2</sup>: 1-1/2", 2", 3", 4", 6", 8" and 10" Sizes

### OMNI C<sup>2</sup>: 1 1/2" - 6"

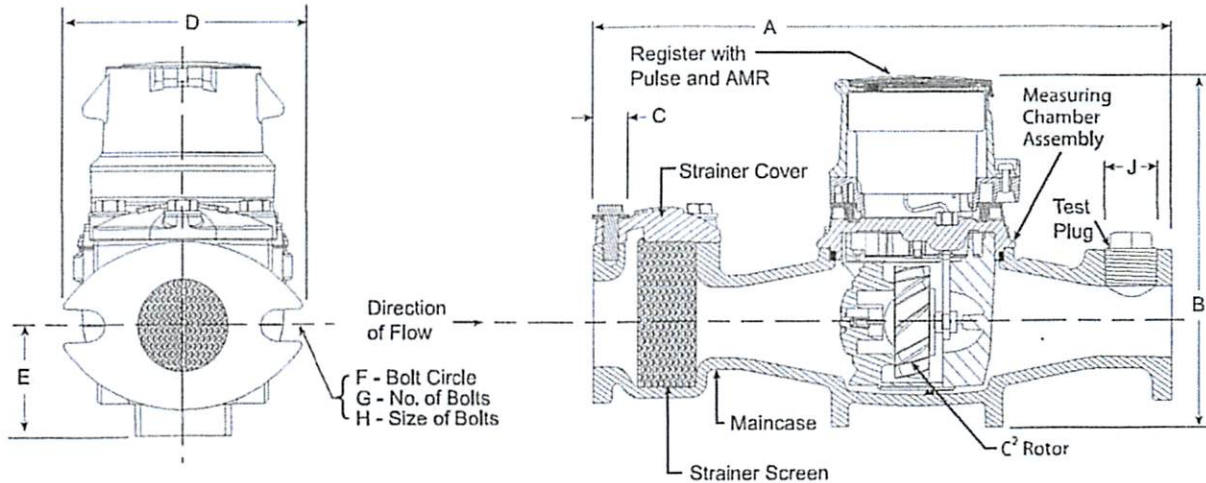

### OMNI C<sup>2</sup>: 8" - 10"

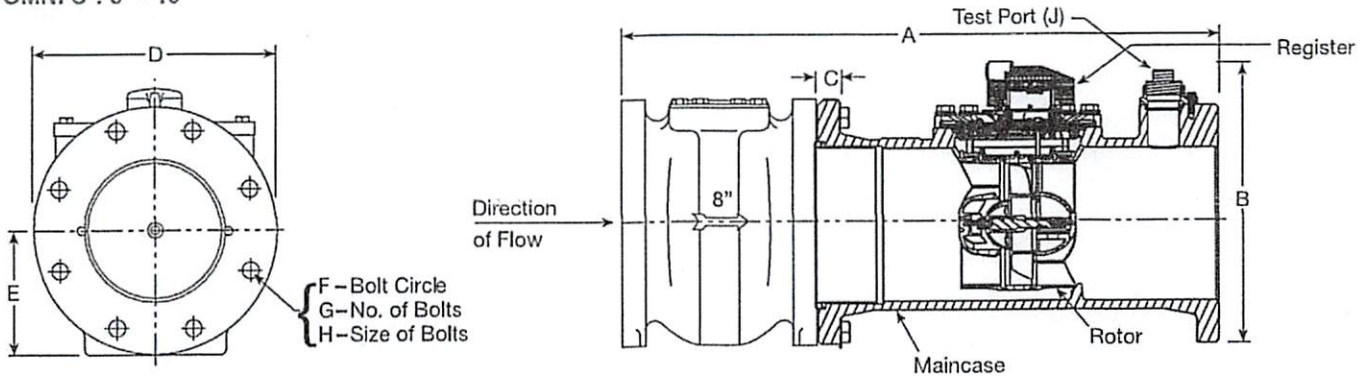

## DIMENSIONS AND NET WEIGHTS

Meter and Pipe Size	Normal Operating Range		Connections	A	B	C	D	E	F	G	H	J	Net Weight	Shipping Weight
1-1/2" DN 40mm	.5 gpm .11 m <sup>3</sup> /hr	200 gpm 45 m <sup>3</sup> /hr	Flanged	13" 330mm	7-7/8" 200mm	15/16" 24mm	5-1/8" 130mm	2-5/16" 59mm	4" 102mm	2	5/8" 16mm	1" 25mm	18.8 lbs. 8.53 kg.	22.5 lbs. 10.20 kg.
2" DN 50mm	.5 gpm .11 m <sup>3</sup> /hr	200 gpm 45 m <sup>3</sup> /hr	Flanged	15-1/4" 387mm	7-7/8" 200mm	1" 25mm	5-3/4" 146mm	2-5/16" 59mm	4-1/2" 114mm	2	3/4" 19mm	1" 25mm	25.4 lbs. 11.39 kg.	32.5 lbs. 14.74 kg.
3" DN 80mm	1 gpm .23 m <sup>3</sup> /hr	500 gpm 114 m <sup>3</sup> /hr	Flanged	17" 432mm	8-3/4" 222mm	3/4" 19mm	7-7/8" 200mm	4-1/8" 105mm	6" 153mm	4	5/8" 16mm	1" 25mm	45 lbs. 20.41 kg.	72.8 lbs. 33.02 kg.
4" DN 100mm	1.5 gpm .34 m <sup>3</sup> /hr	1000 gpm 227 m <sup>3</sup> /hr	Flanged	20" 508mm	11-3/16" 284mm	15/16" 24mm	9-1/8" 232mm	4-3/4" 121mm	7-1/2" 191mm	8	5/8" 16mm	1-1/2" 40mm	64.9 lbs. 29.44 kg.	72.8 lbs. 33.02 kg.
6" DN 150mm	3 gpm .68 m <sup>3</sup> /hr	2500 gpm 5687 m <sup>3</sup> /hr	Flanged	24" 610mm	13-1/4" 336mm	15/16" 24mm	11" 279mm	5-3/4" 146mm	9-1/2" 242mm	8	3/4" 19mm	1-1/2" 40mm	130 lbs. 48.5 kg.	155 lbs. 57.6 kg.
8" DN 200mm	4 gpm .91 m <sup>3</sup> /hr	2700 gpm 614 m <sup>3</sup> /hr	Flanged	30-1/8" 765 mm	15" 381 mm	11/16" 17 mm	13-1/2" 343 mm	6-3/4" 172 mm	11-3/4" 300 mm	8	3/4" 19 mm	2" NPT	471 lbs. 214 kg.	521 lbs. 236 kg.
10" DN 250mm	5 gpm 1.1 m <sup>3</sup> /hr	4000 gpm 908 m <sup>3</sup> /hr	Flanged	41-1/8" 1045mm	19" 485mm	11/16" 17mm	16" 406mm	8-1/2" 216mm	14-1/4" 362mm	12	7/8" 22mm	2" NPT	685 lbs. 311 kg.	745 lbs. 338 kg.



OMNI C<sup>2</sup>: 1-1/2", 2", 3", 4", 6", 8" and 10" Sizes

## SPECIFICATIONS

<b>SERVICE</b>	Measurement of potable and reclaim water. Operating temperature range of 33 °F (56 °C) - 150 °F (65.6 °C)
<b>OPERATING RANGE</b> (100% ± 1.5%)	1-1/2": .5 – 200 GPM (.11 - 45 m <sup>3</sup> /hr) 2": .5 – 200 GPM (.11 - 45 m <sup>3</sup> /hr) 3": 1.0 – 500 GPM (.23 - 114 m <sup>3</sup> /hr) 4": 1.5 – 1000 GPM (.34 - 227 m <sup>3</sup> /hr) 6": 3 – 2000 GPM (.68 - 454 m <sup>3</sup> /hr) 8": 4 – 2700 GPM (0.91 – 614 m <sup>3</sup> /hr) 10": 5-4000 GPM (1.1-908 m <sup>3</sup> /hr)
<b>LOW FLOW</b> (95% – 101.5%)	1-1/2": .25 GPM (.06 m <sup>3</sup> /hr) 2": .25 GPM (.06 m <sup>3</sup> /hr) 3": .5 GPM (.11 m <sup>3</sup> /hr) 4": .75 GPM (.17 m <sup>3</sup> /hr) 6": 1.5 GPM (.34 m <sup>3</sup> /hr) 8": 2.5 GPM (0.57 m <sup>3</sup> /hr) 10": 3.5 GPM (0.8 m <sup>3</sup> /hr)
<b>MAXIMUM CONTINUOUS OPERATION</b>	1-1/2": 160 GPM (36m <sup>3</sup> /hr) 2": 160 GPM (36 m <sup>3</sup> /hr) 3": 400 GPM (91 m <sup>3</sup> /hr) 4": 800 GPM (182 m <sup>3</sup> /hr) 6": 1600 GPM (363 m <sup>3</sup> /hr) 8": 2700 GPM (614 m <sup>3</sup> /hr) 10": 4000 GPM (908 m <sup>3</sup> /hr)
<b>MAXIMUM INTERMITTENT OPERATION</b>	1-1/2": 200 GPM (45 m <sup>3</sup> /hr) 2": 200 GPM (45 m <sup>3</sup> /hr) 3": 500 GPM (114 m <sup>3</sup> /hr) 4": 1000 GPM (227 m <sup>3</sup> /hr) 6": 2000 GPM (454 m <sup>3</sup> /hr) 8": 3400 GPM (773 m <sup>3</sup> /hr) 10": 5000 GPM (1136 m <sup>3</sup> /hr)
<b>PRESSURE LOSS</b>	1-1/2": 6.9 psi @ 160 GPM (48 bar @ 36 m <sup>3</sup> /hr) 2": 4.3 psi @ 160 GPM (.30 bar @ 36 m <sup>3</sup> /hr) 3": 3.2 psi @ 400 GPM (.22 bar @ 91 m <sup>3</sup> /hr) 4": 6.4 psi @ 800 GPM (.51 bar @ 182 m <sup>3</sup> /hr) 6": 5.5 psi @ 1600 GPM (.56 bar @ 363 m <sup>3</sup> /hr) 8": 4 psi @ 2700 GPM (.27 bar @ 614 m <sup>3</sup> /hr) 10": 4.5 psi @ 4000 GPM (.31 bar @ 908 m <sup>3</sup> /hr)
<b>MAXIMUM OPERATING PRESSURE</b>	200 PSI (13.8 bar)
<b>FLANGE CONNECTIONS</b>	U.S. ANSI B16.1 / AWWA Class 125
<b>REGISTER</b>	Fully electronic sealed register with programmable registration (Gal. /Cu.Ft. / Cu. Mtr. / Imp.Gal / Acre Ft.) Programmable AMR/AMI reading and pulse outputs Guaranteed 10 year battery life
<b>NSF APPROVED MATERIALS</b>	<b>Maincase:</b> Coated Ductile Iron <b>Measuring Chamber:</b> Thermoplastic <b>Rotor "Floating Ball":</b> Thermoplastic <b>Radial Bearings:</b> Hybrid Thermoplastic <b>Thrust Bearings:</b> Sapphire/Ceramic Jewel <b>Magnets:</b> Ceramic Magnet <b>Strainer Screen:</b> Stainless Steel <b>Strainer Cover:</b> Coated Ductile Iron <b>Test Plug:</b> Coated Ductile Iron

## OMNI C<sup>2</sup>: 1-1/2", 2", 3", 4", and 6" Sizes

### Headloss Curves

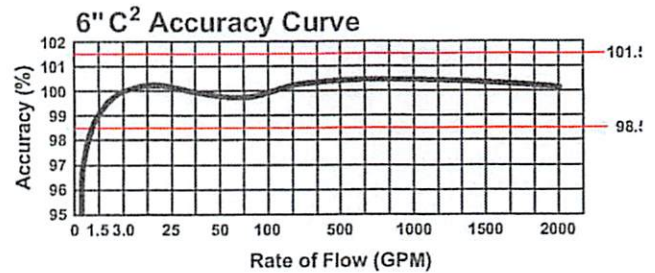
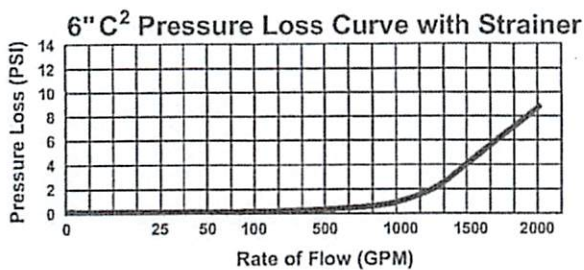
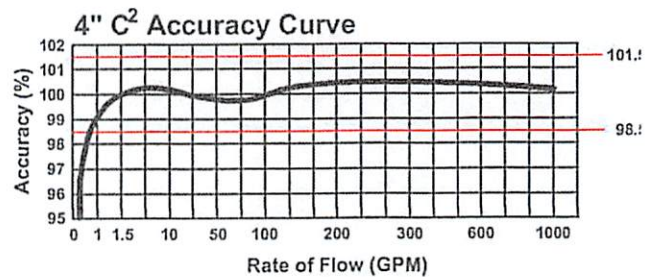
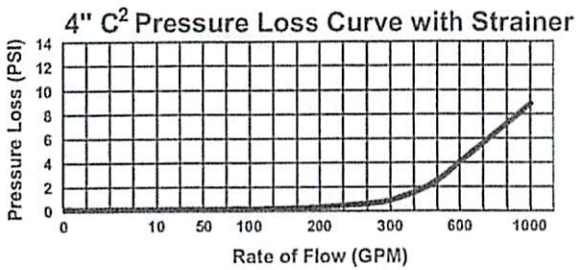
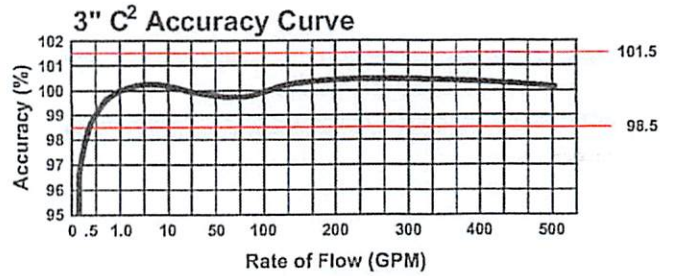
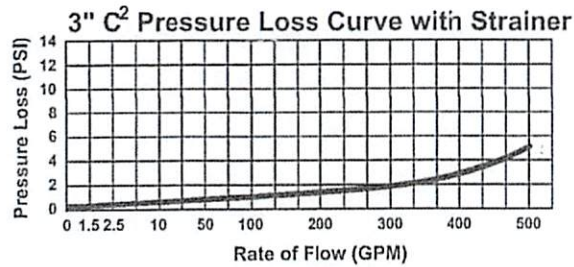
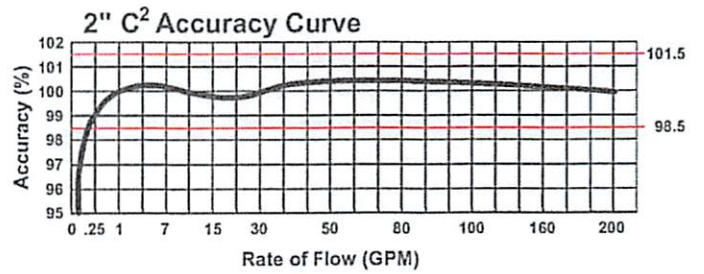
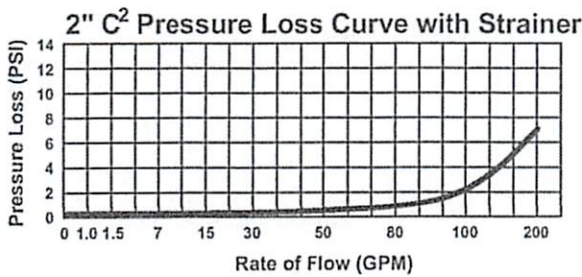
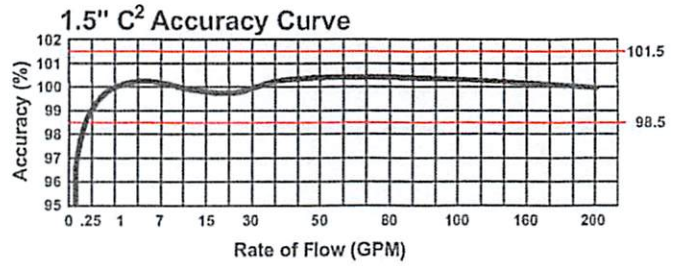
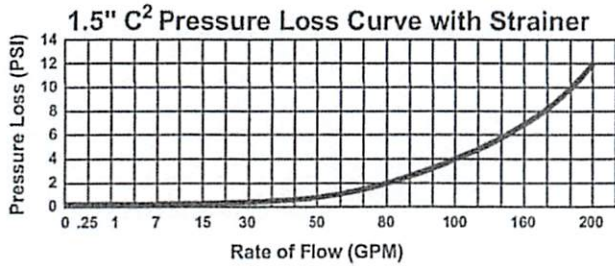

## OMNI C<sup>2</sup>: 8" and 10" Sizes

### Headloss Curves

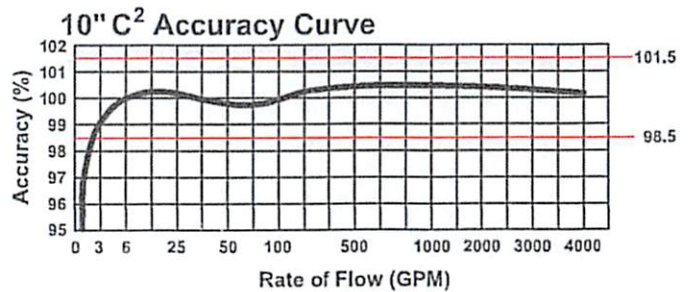
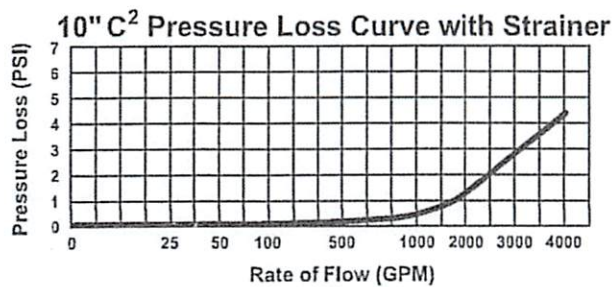
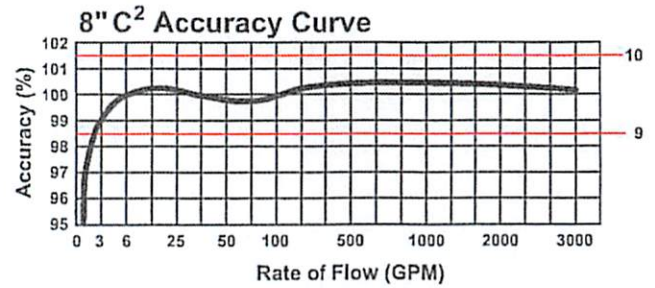
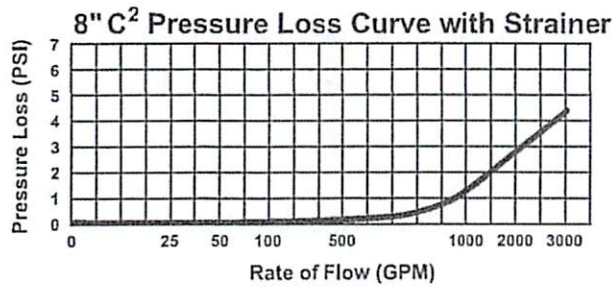

© All products purchased and services performed are subject to Sensus' terms of sale, available at either; <http://na.sensus.com/TC/TermsConditions.pdf> or 1-800-METER-IT. Sensus reserves the right to modify these terms and conditions in its own discretion without notice to the customer.

This document is for informational purposes only, and SENSUS MAKES NO EXPRESS WARRANTIES IN THIS DOCUMENT. FURTHERMORE, THERE ARE NO IMPLIED WARRANTIES, INCLUDING WITHOUT LIMITATION, WARRANTIES AS TO FITNESS FOR A PARTICULAR PURPOSE AND MERCHANTABILITY. ANY USE OF THE PRODUCTS THAT IS NOT SPECIFICALLY PERMITTED HEREIN IS PROHIBITED.

**OMNI™ T<sup>2</sup>**1-1/2", 2", 3", 4", 6", 8" and 10" OMNI T<sup>2</sup> Meter**Description****1-1/2", 2", 3", 4", 6", 8" and 10" Sizes**

The OMNI T<sup>2</sup> meter operation is based on advanced Floating Ball Technology (FBT).

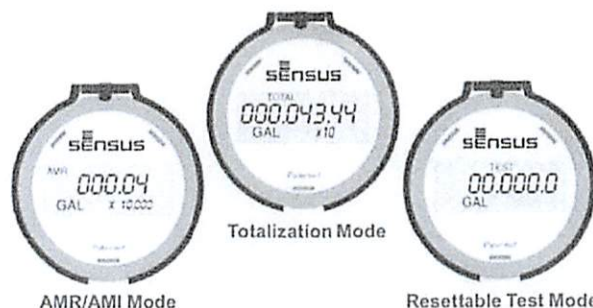
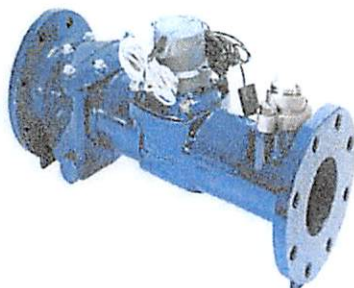
**Features****CONFORMANCE TO STANDARDS**

The OMNI T<sup>2</sup> meter meets and far exceeds the most recent revision of AWWA Standard C701 class II standards. Each meter is performance tested to ensure compliance. All OMNI meters are NSF/ANSI Standard 61, Annex F and G approved.

**PERFORMANCE**

The patented measurement principles of the OMNI T<sup>2</sup> meter assure enhanced accuracy ranges, an overall greater accuracy, and a longer service life than any other comparable class meter produced. The OMNI T<sup>2</sup> meter has no restrictions as to sustained flow rates within its continuous operating range. The floating ball measurement technology allows for flows up to its rated maximum capacity without affecting undue wear or accuracy degradation when installed in any orientation.

**CONSTRUCTION**

The OMNI T<sup>2</sup> meter consists of two basic assemblies; the maincase and the measuring chamber. The measuring chamber assembly includes the "floating ball" impeller with a coated titanium shaft, hybrid axial bearings, integral flow straightener and an all electronic programmable register with protective bonnet. The maincase is made from industry proven Ductile Iron with an approved NSF epoxy coating. Maincase features are; easily removable measuring chamber, unique chamber seal to the maincase using a high pres-

sure o-ring, testing port and a convenient integral strainer.

**OMNI ELECTRONIC REGISTER**

The OMNI T<sup>2</sup> electronic register consist of a hermetically sealed register with an electronic pickup containing no mechanical gearing. The large character LCD displays AMR, Totalization and a Resettable Test Totalizer. OMNI register features; AMR resolution units that are fully programmable, Pulse output frequency that are fully programmable, Integral customer data logging capability, Integral resettable accuracy testing feature compatible with the UniPro Testing Assistant Program, Large, easy-to-read LCD also displays both forward and reverse flow directions and all with a 10-year battery life guarantee.

**MAGNETIC DRIVE**

Meter registration is achieved by utilizing a fully magnetic pickup system. This is accomplished by the magnetic actions of the embedded rotor magnets and the ultra sensitive register pickup probe. The only moving component in water is the "floating ball" impeller.

**MEASURING ELEMENT**

The revolutionary thermoplastic, hydro dynamically balanced impeller floats between the bearings. The Floating Ball Technology (FBT) allows the measuring element to operate virtually without friction or wear, thus creating the extended

upper and lower flow ranges capable on only the OMNI T<sup>2</sup> meter.

**STRAINER**

The OMNI T<sup>2</sup> with the "V" shaped integral strainer using a stainless steel screen along with Floating Ball Technology (FBT) create a design that gives far improved accuracy even in those once thought questionable settings. A removable strainer cover permits easy access to the screen for routine maintenance.

**MAINTENANCE**

The OMNI T<sup>2</sup> meter is designed for easy maintenance. Should any maintenance be required, the measuring chamber and / or strainer cover can be removed independently. Parts and or a replacement measuring chamber may be utilized in the event repairs are needed. Replacement Measuring Chambers Exchange are available for the OMNI T<sup>2</sup> meters and may also be utilized for retrofitting to competitive meters to achieve increased accuracy and extended service life.

**AMR / AMI SYSTEMS:**

Meters and encoders are compatible with current Sensus AMR/AMI systems.

**GUARANTEE:**

Sensus OMNI T<sup>2</sup> Meters are backed by "The Sensus Guarantee." Ask your Sensus representative for details or see Bulletin G-500.

**OMNI T<sup>2</sup>: 1-1/2", 2", 3", 4", 6", 8" and 10" Sizes**

OMNI T<sup>2</sup>: 1 1/2" - 6"

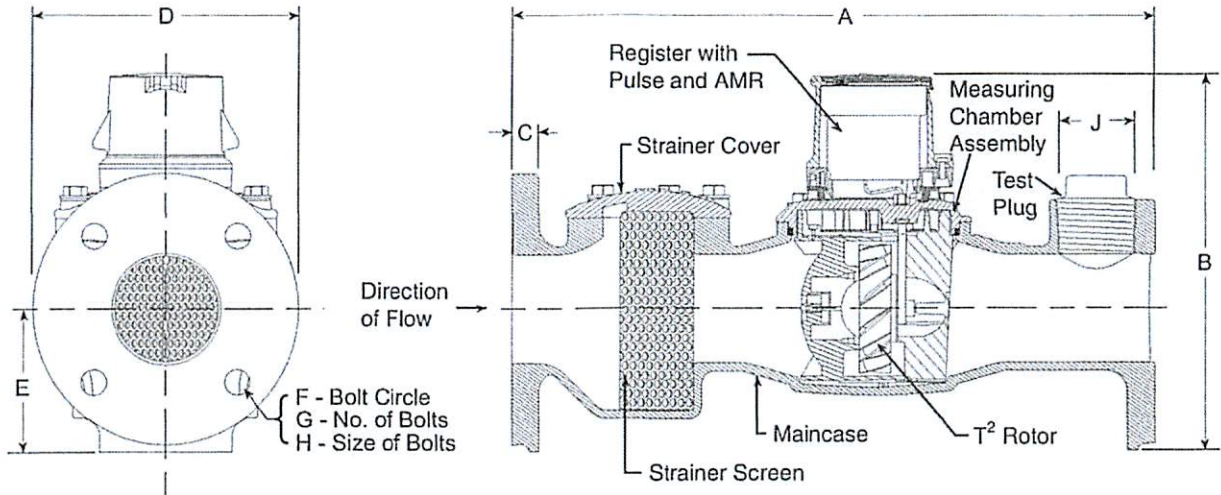

OMNI T<sup>2</sup>: 8" - 10"

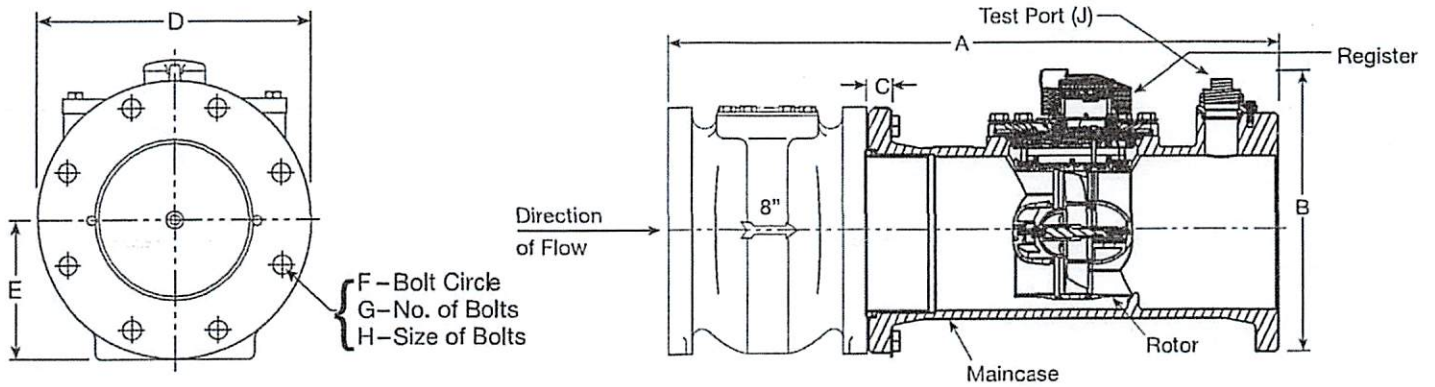

**DIMENSIONS AND NET WEIGHTS**

Meter and Pipe Size	Normal Operating Range		Connections	A	B	C	D	E	F	G	H	J	Net Weight	Shipping Weight
1-1/2" DN 40mm	1.25 gpm .28 m <sup>3</sup> /hr	200 gpm 45 m <sup>3</sup> /hr	Flanged	13" 330mm	7-7/8" 200mm	15/16" 24mm	5-1/8" 130mm	2-5/16" 59mm	4" 102mm	2	5/8" 16mm	1" 25mm	18.8 lbs. 8.53 kg.	22.5 lbs. 10.20 kg.
2" DN 50mm	1.5 gpm .34 m <sup>3</sup> /hr	250 gpm 57 m <sup>3</sup> /hr	Flanged	17" 432mm	7-7/8" 200mm	1" 25mm	5-3/4" 146mm	2-5/16" 59mm	4-1/2" 114mm	2	3/4" 19mm	1-1/2" 40mm	27.4 lbs. 12.42 kg.	34.5 lbs. 15.65 kg.
2" without Strainer DN 50mm	1.5 gpm .34 m <sup>3</sup> /hr	250 gpm 57 m <sup>3</sup> /hr	Flanged	10" 254mm	7-7/8" 200mm	1" 25mm	5-3/4" 146mm	2-5/16" 59mm	4-1/2" 114mm	2	3/4" 19mm	N/A	17.4 lbs. 7.9 kg.	24.5 lbs. 11.11 kg.
3" DN 80mm	2.5 gpm .57 m <sup>3</sup> /hr	650 gpm 148 m <sup>3</sup> /hr	Flanged	19" 432mm	8-3/4" 222mm	3/4" 19mm	7-7/8" 200mm	4-1/8" 105mm	6" 153mm	4	5/8" 16mm	2" 50mm	48.5 lbs. 22.00 kg.	57.4 lbs. 26.04 kg.
4" DN 100mm	3.0 gpm .68 m <sup>3</sup> /hr	1250 gpm 284 m <sup>3</sup> /hr	Flanged	23" 584mm	11-3/16" 284mm	15/16" 24mm	9-1/8" 232mm	4-3/4" 121mm	7-1/2" 191mm	8	5/8" 16mm	2" 50mm	67.9 lbs. 30.80 kg.	75.8 lbs. 34.38 kg.
6" DN 150mm	4 gpm .91 m <sup>3</sup> /hr	2500 gpm 568 m <sup>3</sup> /hr	Flanged	27" 685mm	13-1/4" 336mm	15/16" 24mm	11" 279mm	5-3/4" 146mm	9-1/2" 242mm	8	3/4" 19mm	2" 50mm	140 lbs. 63.6 kg.	165 lbs. 74.8 kg.
8" DN 200mm	5 gpm 1.1 m <sup>3</sup> /hr	3500 gpm 795 m <sup>3</sup> /hr	Flanged	30-1/8" 765 mm	15" 381 mm	11/16" 17 mm	13-1/2" 343 mm	6-3/4" 172 mm	11-3/4" 300 mm	8	3/4" 19 mm	2" NPT	471 lbs. 214 kg.	521 lbs. 236 kg.
10" DN 250mm	6 gpm 1.4 m <sup>3</sup> /hr	5500 gpm 1249 m <sup>3</sup> /hr	Flanged	41-1/8" 485mm	19" 485mm	11/16" 17mm	16" 406mm	8-1/2" 216mm	14-1/4" 362mm	12	7/8" 22mm	2" NPT	685 lbs. 311 kg.	745 lbs. 338 kg.

OMNI T<sup>2</sup>: 1-1/2", 2", 3", 4", 6", 8" and 10" Sizes

## SPECIFICATIONS

<b>SERVICE</b>	Measurement of potable and reclaim water. Operating temperature range of 33 °F (56 °C) - 150 °F (65.6 °C)																		
<b>OPERATING RANGE</b> (100% ± 1.5%)	1-1/2": 1.25 – 200 GPM (.28 - 45 m <sup>3</sup> /hr) 2" and 2" without Strainer: 1.5 – 250 GPM (.34 – 57 m <sup>3</sup> /hr) 3": 2.5 – 650 GPM (.57 – 148 m <sup>3</sup> /hr) 4": 3 – 1250 GPM (.68 – 284 m <sup>3</sup> /hr) 6": 4 – 2500 GPM (.91 – 568 m <sup>3</sup> /hr) 8": 5 – 3500 GPM (1.1-795 m <sup>3</sup> /hr) 10": 6 – 5500 GPM (1.4 - 1249 m <sup>3</sup> /hr)																		
<b>LOW FLOW</b> (95% – 101.5%)	1-1/2": .75 GPM (.17 m <sup>3</sup> /hr) 2" and 2" without Strainer: 1.0 GPM (.23 m <sup>3</sup> /hr) 3": 1.5 GPM (.34 m <sup>3</sup> /hr) 4": 2.0 GPM (.45 m <sup>3</sup> /hr) 6": 2.5 GPM (.57 m <sup>3</sup> /hr) 8": 4 GPM (0.9 m <sup>3</sup> /hr) 10": 5 GPM (1.1 m <sup>3</sup> /hr)																		
<b>MAXIMUM CONTINUOUS OPERATION</b>	1-1/2": 160 GPM (36 m <sup>3</sup> /hr) 2" and 2" without Strainer: 200 GPM (45 m <sup>3</sup> /hr) 3": 500 GPM (114 m <sup>3</sup> /hr) 4": 1000 GPM (227 m <sup>3</sup> /hr) 6": 2000 GPM (454 m <sup>3</sup> /hr) 8": 3500 GPM (795 m <sup>3</sup> /hr) 10": 5500 GPM (1249 m <sup>3</sup> /hr)																		
<b>MAXIMUM INTERMITTENT OPERATION</b>	1-1/2": 200 GPM (45 m <sup>3</sup> /hr) 2" and 2" without Strainer: 250 GPM (57 m <sup>3</sup> /hr) 3": 650 GPM (148 m <sup>3</sup> /hr) 4": 1250 GPM (284 m <sup>3</sup> /hr) 6": 2500 GPM (568 m <sup>3</sup> /hr) 8": 4700 GPM (1067 m <sup>3</sup> /hr) 10": 7000 GPM (1590 m <sup>3</sup> /hr)																		
<b>PRESSURE LOSS</b>	1-1/2": 6.9 psi @ 160 GPM (48 bar @ 36 m <sup>3</sup> /hr) 2" and 2" without Strainer: 7.0 psi @ 200 GPM (.48 bar @ 45 m <sup>3</sup> /hr) 3": 5.1 psi @ 500 GPM (.35 bar @ 114 m <sup>3</sup> /hr) 4": 8.7 psi @ 1000 GPM (.60 bar @ 227 m <sup>3</sup> /hr) 6": 8.2 psi @ 2000 GPM (.56 bar @ 454 m <sup>3</sup> /hr) 8": 5.1 psi @ 3500 GPM (.35 bar @ 795 m <sup>3</sup> /hr) 10": 7.2 psi @ 5500 GPM (.50 bar @ 1249 m <sup>3</sup> /hr)																		
<b>MAXIMUM OPERATING PRESSURE</b>	200 PSI (13.8 bar)																		
<b>FLANGE CONNECTIONS</b>	U.S. ANSI B16.1 / AWWA Class 125																		
<b>REGISTER</b>	Fully electronic sealed register with programmable registration (Gal. /Cu.Ft./ Cu. Mtr. / Imp.Gal / Acre Ft.) Programmable AMR/AMI reading and pulse outputs Guaranteed 10 year battery life																		
<b>NSF APPROVED MATERIALS</b>	<table> <tr> <td><b>Maincase:</b></td> <td>Coated Ductile Iron</td> </tr> <tr> <td><b>Measuring Chamber:</b></td> <td>Thermoplastic</td> </tr> <tr> <td><b>Rotor "Floating Ball":</b></td> <td>Thermoplastic</td> </tr> <tr> <td><b>Radial Bearings:</b></td> <td>Hybrid Thermoplastic</td> </tr> <tr> <td><b>Thrust Bearings:</b></td> <td>Sapphire/Ceramic Jewel</td> </tr> <tr> <td><b>Magnets:</b></td> <td>Ceramic Magnet</td> </tr> <tr> <td><b>Strainer Screen:</b></td> <td>Stainless Steel</td> </tr> <tr> <td><b>Strainer Cover:</b></td> <td>Coated Ductile Iron</td> </tr> <tr> <td><b>Test Plug:</b></td> <td>Coated Ductile Iron</td> </tr> </table>	<b>Maincase:</b>	Coated Ductile Iron	<b>Measuring Chamber:</b>	Thermoplastic	<b>Rotor "Floating Ball":</b>	Thermoplastic	<b>Radial Bearings:</b>	Hybrid Thermoplastic	<b>Thrust Bearings:</b>	Sapphire/Ceramic Jewel	<b>Magnets:</b>	Ceramic Magnet	<b>Strainer Screen:</b>	Stainless Steel	<b>Strainer Cover:</b>	Coated Ductile Iron	<b>Test Plug:</b>	Coated Ductile Iron
<b>Maincase:</b>	Coated Ductile Iron																		
<b>Measuring Chamber:</b>	Thermoplastic																		
<b>Rotor "Floating Ball":</b>	Thermoplastic																		
<b>Radial Bearings:</b>	Hybrid Thermoplastic																		
<b>Thrust Bearings:</b>	Sapphire/Ceramic Jewel																		
<b>Magnets:</b>	Ceramic Magnet																		
<b>Strainer Screen:</b>	Stainless Steel																		
<b>Strainer Cover:</b>	Coated Ductile Iron																		
<b>Test Plug:</b>	Coated Ductile Iron																		

## OMNI T<sup>2</sup>: 1-1/2", 2", 3", 4", 6", 8" and 10" Sizes

### Headloss Curves

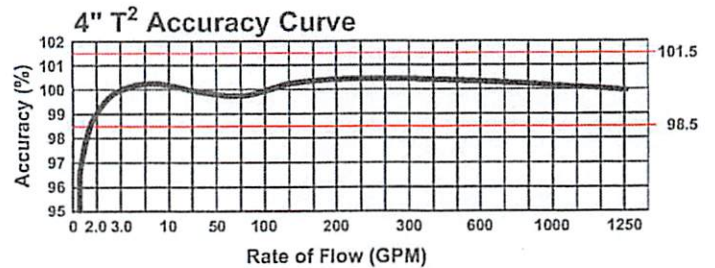
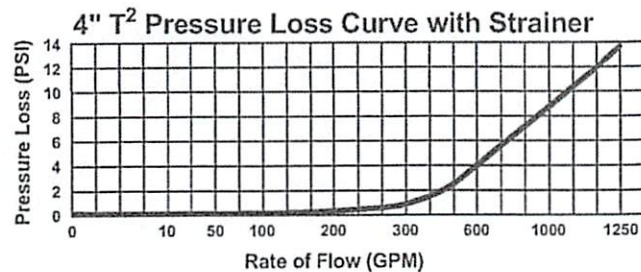
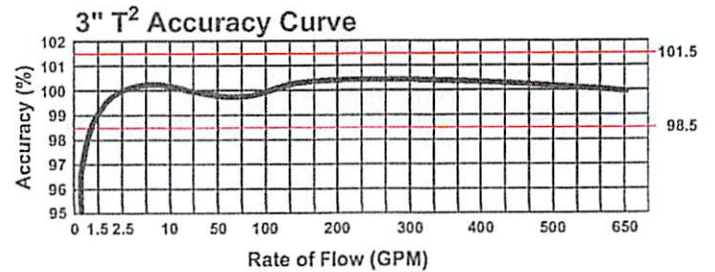
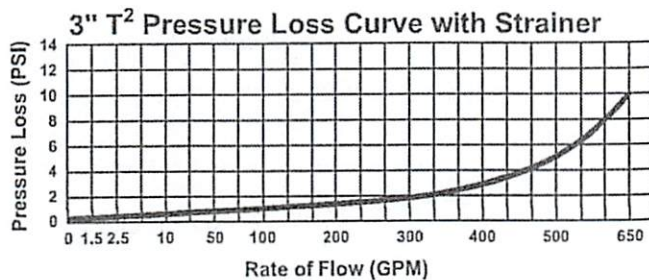
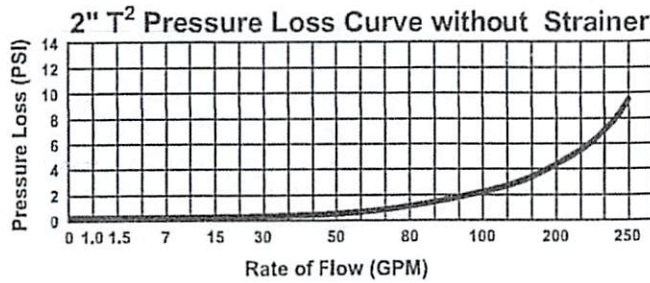
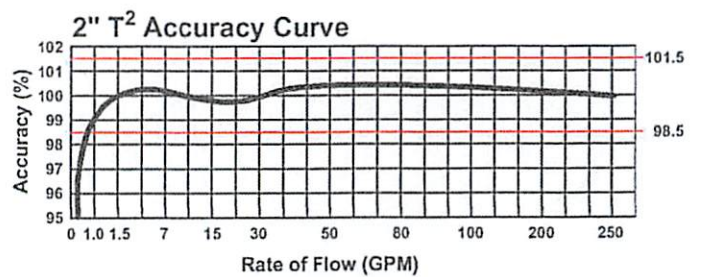
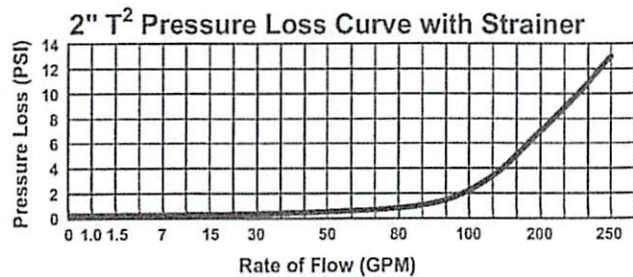
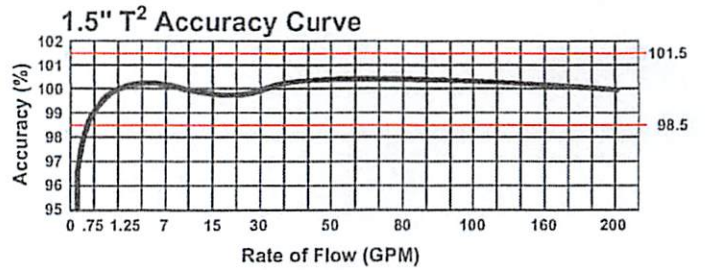
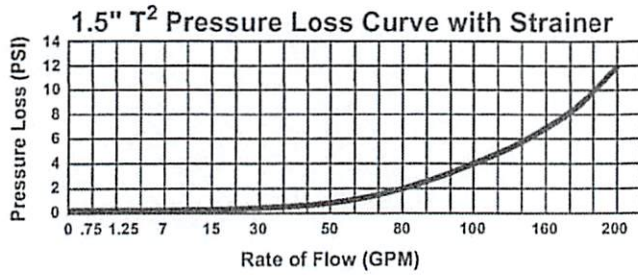

## OMNI T<sup>2</sup>: 1-1/2", 2", 3", 4", 6", 8" and 10" Sizes

### Headloss Curves

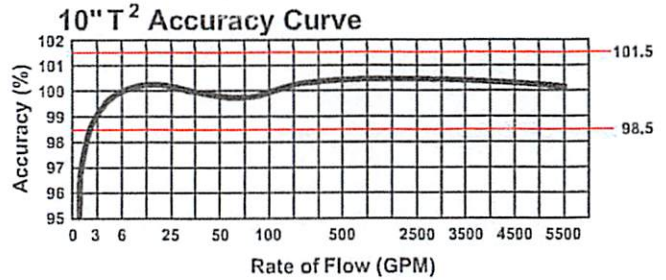
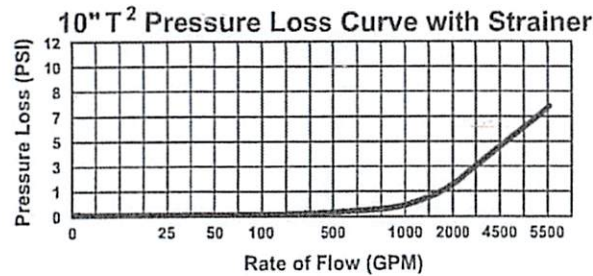
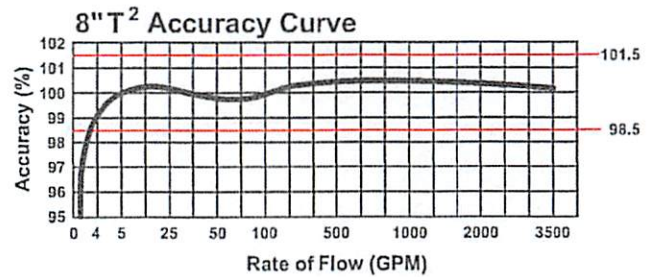
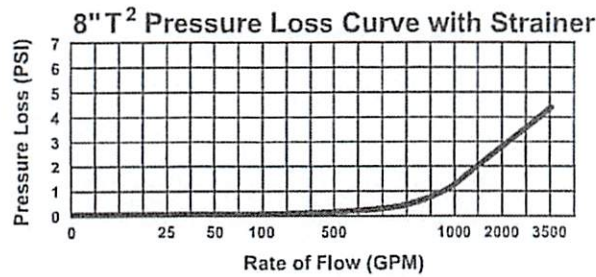
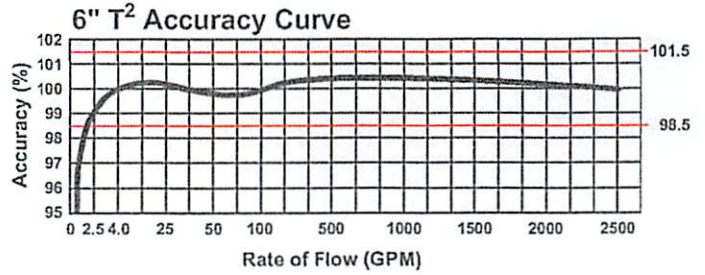
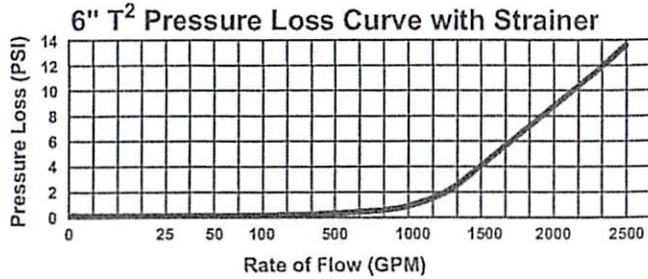

© All products purchased and services performed are subject to Sensus' terms of sale, available at either; <http://na.sensus.com/TC/TermsConditions.pdf> or 1-800-METER-IT. Sensus reserves the right to modify these terms and conditions in its own discretion without notice to the customer.

This document is for informational purposes only, and SENSUS MAKES NO EXPRESS WARRANTIES IN THIS DOCUMENT. FURTHERMORE, THERE ARE NO IMPLIED WARRANTIES, INCLUDING WITHOUT LIMITATION, WARRANTIES AS TO FITNESS FOR A PARTICULAR PURPOSE AND MERCHANTABILITY. ANY USE OF THE PRODUCTS THAT IS NOT SPECIFICALLY PERMITTED HEREIN IS PROHIBITED.



**OMNI™ F<sup>2</sup>**4", 6", 8" and 10" OMNI F<sup>2</sup> Meter**Description****4", 6", 8" and 10" Sizes**

The OMNI F<sup>2</sup> meter operation is based on advanced Floating Ball Technology (FBT).

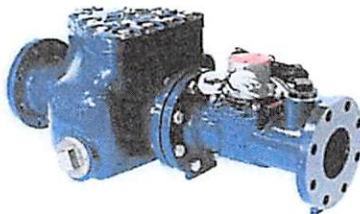
**Features****CONFORMANCE TO STANDARDS**

The OMNI F<sup>2</sup> meter meets and far exceeds the most recent revision of AWWA Standard C703 class II. Additionally, the meter does not require a valve to meet these standards. Each meter is performance tested to ensure compliance. All OMNI meters are NSF/ANSI Standard 61, Annex F and G approved. The OMNI F<sup>2</sup> meter is UL (Underwriters Laboratories) Listed and FM (Factory Mutual) approved for use on fire protection and domestic water applications.

**PERFORMANCE**

The patented measurement principles of the OMNI F<sup>2</sup> meter assure enhanced accuracy ranges, an overall greater accuracy, and a longer service life than any other comparable class meter produced. The F<sup>2</sup> meter has no restrictions as to sustained flow rates within its continuous operating range. The floating ball measurement technology allows for flows up to its rated maximum capacity without undue wear or accuracy degradation.

**CONSTRUCTION**

The OMNI F<sup>2</sup> meter consists of two basic assemblies; the maincase and the measuring chamber. The measuring chamber assembly includes the "floating ball" impeller with a coated titanium shaft, hybrid axial bearings, integral flow straightener and an all electronic programmable register with protective bonnet. The maincase is made from industry proven Ductile Iron with an approved NSF epoxy coating. Maincase features are; easily removable measuring chamber, unique chamber

seal to the maincase using a high pressure o-ring, testing port and a convenient integral strainer with optional drain/debris-flushing ports.

**OMNI ELECTRONIC REGISTER**

The OMNI F<sup>2</sup> electronic register is hermetically sealed with electronic pickup containing no mechanical gearing. The large character LCD displays AMR, Totalization and a Resettable Test Totalizer. OMNI register features; AMR resolution units that are fully programmable, Pulse output frequency that are fully programmable, Integral customer data logging capability, Integral resettable accuracy testing feature compatible with the UniPro Testing Assistant Program, Large, easy-to-read LCD also displays both forward and reverse flow directions and all with a 10-year battery life guarantee.

**MAGNETIC DRIVE**

Meter registration is achieved by utilizing a fully magnetic pickup system. This is accomplished by the magnetic actions of the embedded rotor magnets and the ultra sensitive register pickup probe. The only moving component in water is the "floating ball" impeller.

**MEASURING ELEMENT**

The revolutionary thermoplastic, hydro dynamically balanced impeller floats between the bearings. The Floating Ball Technology (FBT) allows the measuring element to operate virtually without friction or wear, thus creating the extended upper and lower flow ranges capable on only the OMNI F<sup>2</sup> meter.

**STRAINER**

The OMNI F<sup>2</sup> meter includes the Sensus designed "V" shaped UL Listed/FM approved strainer which utilizes a stainless steel screen along with Floating Ball Technology (FBT) to create a design that gives far improved accuracy even in those once thought questionable settings. A removable strainer cover permits easy access to the screen for routine maintenance. Optional drain ports, located at the back lower corners of the strainer body, allow for easy discharging of debris without the need to remove the cover.

**MAINTENANCE**

The OMNI F<sup>2</sup> meter is designed for easy maintenance. Should any maintenance be required, the measuring chamber and/or strainer cover can be removed independently. Parts and or a replacement measuring chamber may be utilized in the event repairs are needed. Replacement Measuring Chambers are available for the OMNI F<sup>2</sup> meters.

**AMR / AMI SYSTEMS**

Meters and encoders are compatible with current Sensus AMR/AMI systems.

**GUARANTEE**

Sensus OMNI F<sup>2</sup> Meters are backed by "The Sensus Guarantee." Ask your Sensus representative for details or see Bulletin G-500.

OMNI F<sup>2</sup>: 4", 6", 8" and 10"

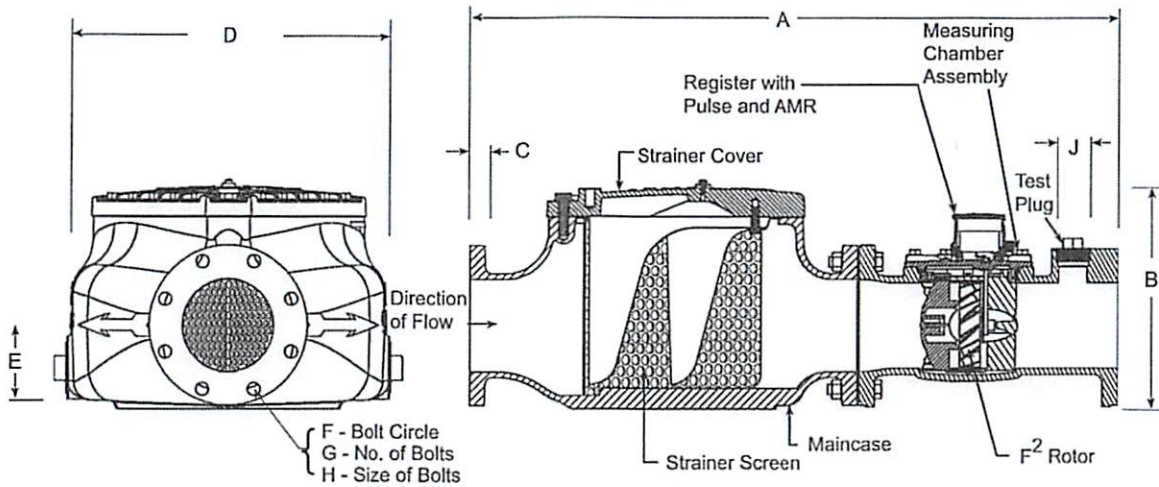

DIMENSIONS AND NET WEIGHTS

Meter and Pipe Size	Normal Operating Range		Connections	A	B	C	D	E	F	G	H	J	Net Weight	Shipping Weight	Standard Fireline
4" DN 100mm	1.5 gpm .34 m <sup>3</sup> /hr	1000 gpm 227 m <sup>3</sup> /hr	Flanged	33" 838mm	13-11/16" 348mm	15/16" 24mm	17-1/2" 446mm	4-3/4" 121mm	7-1/2" 191mm	8	5/8" 16mm	2" 50mm	212 lbs. 96 kg.	252 lbs. 115 kg.	51-7/8" (1317mm)
6" DN 150mm	3.0 gpm .681 m <sup>3</sup> /hr	2000 gpm 454 m <sup>3</sup> /hr	Flanged	45" 1143mm	15-3/4" 400mm	15/16" 24mm	22-3/8" 569mm	5-3/4" 146mm	9-1/2" 242mm	8	3/4" 19mm	2" 50mm	394 lbs. 179 kg.	449 lbs. 204 kg.	67-5/8" (1717mm)
8" DN 200mm	4 gpm .91 m <sup>3</sup> /hr	3500 gpm 795 m <sup>3</sup> /hr	Flanged	53" 1346mm	18-1/2" 470mm	11/16" 17mm	31" 787mm	6-3/4" 172mm	11-3/4" 298mm	8	3/4" 19mm	2" NPT	736 lbs. 334 kg.	786 lbs. 357 kg.	77" (1956mm)
10" DN 250mm	5 gpm 1.1 m <sup>3</sup> /hr	5500 gpm 1249 m <sup>3</sup> /hr	Flanged	68" 1727mm	22-1/4" 565mm	11/16" 17mm	37-1/3" 947mm	8-1/2" 216mm	14-1/4" 362mm	12	7/8" 22mm	2" NPT	1155 lbs. 524 kg.	1215 lbs. 551 kg.	90" (2286mm)

\* Standard Fireline lay length with optional spool piece added.

SPECIFICATIONS

<b>SERVICE</b>	Measurement of potable and reclaim water. Operating temperature range of 33 °F (56 °C) - 150 °F (65.6 °C)
<b>OPERATING RANGE</b> (100% ± 1.5%)	4": 1.5 – 1000 GPM (.34 - 227 m <sup>3</sup> /hr) 6": 3.0 – 2000 GPM (.34 - 227 m <sup>3</sup> /hr) 8": 4 – 3500 GPM (0.91-795 m <sup>3</sup> /hr) 10": 5 – 5500 GPM (1.1-1249 m <sup>3</sup> /hr)
<b>LOW FLOW</b> (95% – 101.5%)	4": .75 GPM (.06 m <sup>3</sup> /hr) 6": 1.5 GPM (.06 m <sup>3</sup> /hr) 8": 2.5 GPM (0.57 m <sup>3</sup> /hr) 10": 3.5 GPM (0.8 m <sup>3</sup> /hr)
<b>UL MINIMUM FLOW</b>	8": 97% @ 3 GPM (0.68 m <sup>3</sup> /hr) 10": 97% @ 4 GPM (0.9 m <sup>3</sup> /hr)
<b>MAXIMUM CONTINUOUS OPERATION</b>	4": 1000 GPM (227 m <sup>3</sup> /hr) 6": 2000 GPM (454 m <sup>3</sup> /hr) 8": 3500 GPM (795 m <sup>3</sup> /hr) 10": 5500 GPM (1249 m <sup>3</sup> /hr)
<b>MAXIMUM INTERMITTENT OPERATION</b>	4": 1250 GPM (284 m <sup>3</sup> /hr) 6": 2500 GPM (568 m <sup>3</sup> /hr) 8": 4700 GPM (1067 m <sup>3</sup> /hr) 10": 7000 GPM (1590 m <sup>3</sup> /hr)

<b>PRESSURE LOSS</b>	4": 6.4 psi @ 1000 GPM (.60 bar @ 227 m <sup>3</sup> /hr) 6": 6.7 psi @ 2000 GPM (.56 bar @ 454 m <sup>3</sup> /hr) 8": 5 psi @ 3500 GPM (.34 bar @ 795 m <sup>3</sup> /hr) 10": 7 psi @ 5500 GPM (.48 bar @ 1249 m <sup>3</sup> /hr)																		
<b>MAXIMUM OPERATING PRESSURE</b>	175 PSI (12 bar)																		
<b>FLANGE CONNECTIONS</b>	U.S. ANSI B16.1 / AWWA Class 125																		
<b>REGISTER</b>	Fully electronic sealed register with programmable registration (Gal./Cu.Ft./ Cu. Mtr. / Imp.Gal / Acre Ft.) Programmable AMR/AMI reading and pulse outputs Guaranteed 10 year battery life																		
<b>NSF APPROVED MATERIALS</b>	<table border="0"> <tr> <td><b>Maincase:</b></td> <td>Coated Ductile Iron</td> </tr> <tr> <td><b>Measuring Chamber:</b></td> <td>Thermoplastic</td> </tr> <tr> <td><b>Rotor "Floating Ball":</b></td> <td>Thermoplastic</td> </tr> <tr> <td><b>Radial Bearings:</b></td> <td>Hybrid Thermoplastic</td> </tr> <tr> <td><b>Thrust Bearings:</b></td> <td>Sapphire/Ceramic Jewel</td> </tr> <tr> <td><b>Magnets:</b></td> <td>Ceramic Magnet</td> </tr> <tr> <td><b>Strainer Screen:</b></td> <td>Stainless Steel</td> </tr> <tr> <td><b>Strainer Cover:</b></td> <td>Coated Ductile Iron</td> </tr> <tr> <td><b>Test Plug:</b></td> <td>Coated Ductile Iron</td> </tr> </table>	<b>Maincase:</b>	Coated Ductile Iron	<b>Measuring Chamber:</b>	Thermoplastic	<b>Rotor "Floating Ball":</b>	Thermoplastic	<b>Radial Bearings:</b>	Hybrid Thermoplastic	<b>Thrust Bearings:</b>	Sapphire/Ceramic Jewel	<b>Magnets:</b>	Ceramic Magnet	<b>Strainer Screen:</b>	Stainless Steel	<b>Strainer Cover:</b>	Coated Ductile Iron	<b>Test Plug:</b>	Coated Ductile Iron
<b>Maincase:</b>	Coated Ductile Iron																		
<b>Measuring Chamber:</b>	Thermoplastic																		
<b>Rotor "Floating Ball":</b>	Thermoplastic																		
<b>Radial Bearings:</b>	Hybrid Thermoplastic																		
<b>Thrust Bearings:</b>	Sapphire/Ceramic Jewel																		
<b>Magnets:</b>	Ceramic Magnet																		
<b>Strainer Screen:</b>	Stainless Steel																		
<b>Strainer Cover:</b>	Coated Ductile Iron																		
<b>Test Plug:</b>	Coated Ductile Iron																		

## OMNI F<sup>2</sup>: 4", 6", 8" and 10"

### Headloss Curves

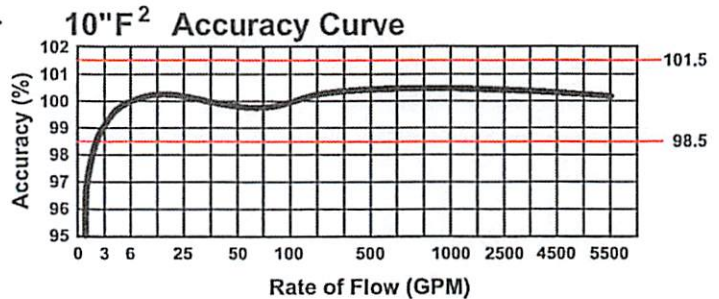
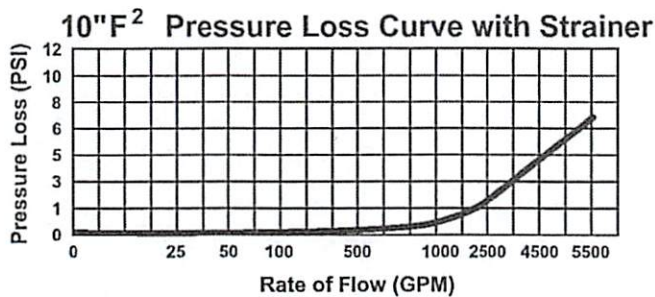
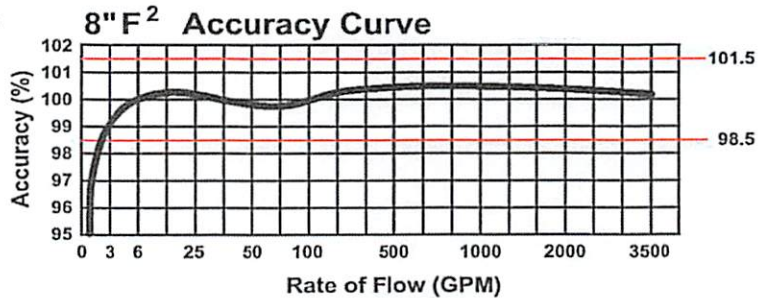
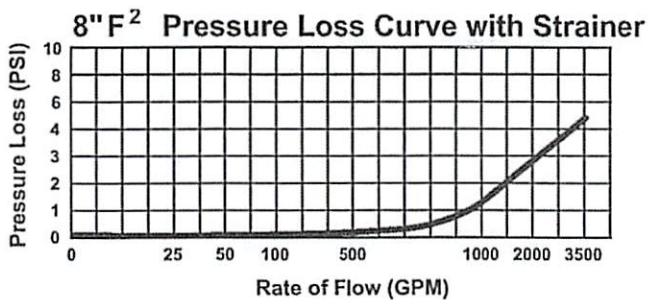
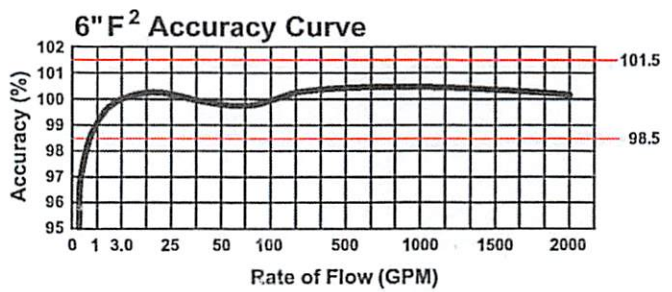
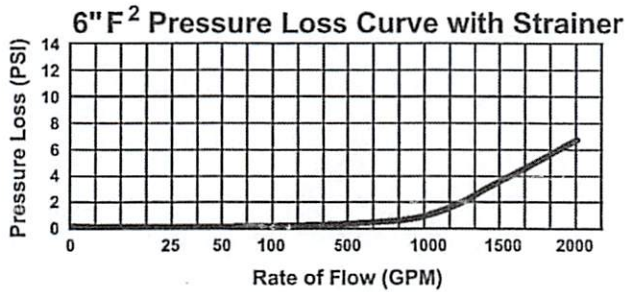
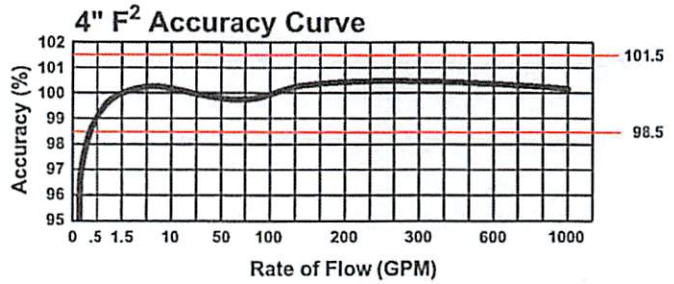
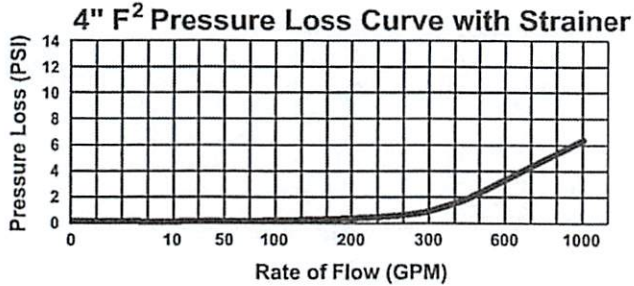

All products purchased and services performed are subject to Sensus' terms of sale, available at either: <http://na.sensus.com/TC/TermsConditions.pdf> or 1-800-METER-IT. Sensus reserves the right to modify terms and conditions in its own discretion without notice to the customer.

This document is for informational purposes only, and SENSUS MAKES NO EXPRESS WARRANTIES IN THIS DOCUMENT, FURTHERMORE, THERE ARE NO IMPLIED WARRANTIES, INCLUDING WITHOUT LIMITATION, WARRANTIES AS TO FITNESS FOR A PARTICULAR PURPOSE AND MERCHANTABILITY. ANY USE OF THE PRODUCTS THAT IS NOT SPECIFICALLY PERMITTED HEREIN IS PROHIBITED.



## RT Series - 19 gauge conductor

### Description

Water blocking reinforced tracer wire used for direct burial locating purposes in the telecommunications, gas, sewer or water utilities. Insulated metallic conductor enables location of all-dielectric cables, gas lines, sewer lines or water pipes.

### Features & Benefits

- ▲ Durably printed with sequential footage or meter markings\*
- ▲ Conductor additionally protected by product construction
- ▲ Market specific coloring for easy identification
- ▲ Water blocking yarns
- ▲ Polyethylene jacket
- ▲ Low elongation for enhanced worker safety
- ▲ Lightweight and easy to handle and install
- ▲ Packaged on sturdy recyclable plastic reels
- ▲ Corrosion-resistant conductor functions at a wide range of frequencies and is compatible with any standard transmitting / receiving equipment
- ▲ Fungus resistant
- ▲ NEPTCO TRACE-SAFE® identification tags included with every reel

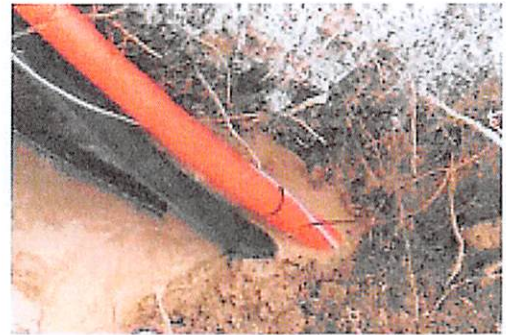

Please refer to NEPTCO's TRACE-SAFE® Water Blocking Tracer Wire Splicing Instructions.

TRACE-SAFE® WATER BLOCKING TRACER WIRE PRODUCT ORDERING INFORMATION					
Product	Color Code	Market	Strength		Nominal Diameter
			lbs.	(kg)	
RT1800W	Orange	Telecommunications	1800	(818)	.235"
RT1801W	Yellow	Gas	1800	(818)	.235"
RT1802W	Blue	Water	1800	(818)	.235"
RT1803W	Green	Sewer	1800	(818)	.235"
RT1804W	Purple	Reclamation	1800	(818)	.235"

\* Also available unprinted

# TRACE-SAFE®

## WATER BLOCKING TRACER WIRE

US Pat. No. 7,932,469; other patents pending

<p><b>TS-19</b> <b>TRACE-SAFE CONNECTOR</b> <b>MAIN LINE to LATERAL/TAP (IVORY)</b></p> <p>1-10-12</p> <p>NEPTCO Incorporated Pawtucket, RI 02861 (401) 722-5500</p> <p>*Trace Safe wire is oval in cross-section</p> <p><b>1</b> Hold bottom of connector perpendicular to the main line wire, with top of box facing away. Insert main line wire into top slot of box. Push wire into place with thumb.</p>	<p><b>2</b> Hold main line wire and rotate connector 90 degrees until flat</p> <p><b>3</b> Place top of connector on loosely (1/8"). Line up lateral/tap wire to the open hole of the connector. Slide wire through the connector, making contact with the back wall. Press connector together with fingers.</p> <p><b>4</b> Place channel lock pliers on installation pads and squeeze together until closed.</p>	
<p><b>TS-18-IL</b> <b>TRACE-SAFE CONNECTOR</b> <b>IN-LINE BUTT SPLICE (GRAY)</b></p> <p>12-20-11</p> <p>NEPTCO Incorporated Pawtucket, RI 02861 (401) 722-5500</p> <p>*Trace Safe wire is oval in cross-section</p> <p><b>WRONG</b></p> <p><b>CORRECT</b></p> <p><b>1</b> Place top of connector on loosely (no more than 1/8"). Line up Trace-Safe wire to the larger open hole of the connector. Slide wire through the connector, making contact with the back wall, making sure the wire clears the teeth. Insert second wire into opposite hole, making contact with the back wall. Press together with fingers to lock wires together in position.</p> <p><b>2</b> Place channel lock pliers on installation pads and squeeze together until closed.</p>	<p><b>TS-12-19</b> <b>TRACE-SAFE CONNECTOR</b> <b>12 AWG MAIN LINE to LATERAL/TAP (BROWN)</b></p> <p>1-4-12</p> <p>NEPTCO Incorporated Pawtucket, RI 02861 (401) 722-5500</p> <p>*Trace Safe wire is oval in cross-section</p> <p><b>1</b> Hold bottom of connector up to the 12 AWG main line wire, with top of box facing away. Insert main line wire into top slot of box. Push wire into place with thumb.</p> <p><b>2</b> Place top of connector on loosely (no more than 1/8"). Line up (lateral/tap) Trace-Safe wire to the open hole (bottom) of the connector. Slide wire through the connector, making contact with the back wall, making sure the wire clears the teeth. Press together with fingers to lock wires together in position.</p> <p><b>3</b> Place channel lock pliers on installation pads and squeeze together until closed.</p>	<p><b>TS-12-19-IL</b> <b>TRACE-SAFE CONNECTOR</b> <b>IN-LINE BUTT SPLICE (BLACK)</b></p> <p>1-4-12</p> <p>NEPTCO Incorporated Pawtucket, RI 02861 (401) 722-5500</p> <p>*Trace-Safe wire is oval in cross-section</p> <p><b>WRONG</b></p> <p><b>CORRECT</b></p> <p><b>1</b> Place top of connector on loosely (no more than 1/8"). Line up Trace-Safe wire to the larger open hole of the connector. Slide wire through the connector, making contact with the back wall, making sure the wire clears the teeth. Insert 12 AWG wire into opposite hole, making contact with the back wall. Press together with fingers to lock wires together in position.</p> <p><b>2</b> Place channel lock pliers on installation pads and squeeze together until closed.</p>

Figure 3 - Installation Instructions for the Trace Safe Connectors

**WARNING** TRACE-SAFE® Water Blocking Tracer Wire: To promote detection of underground cables and utilities - As with any conductor, it has the potential to transfer electrical energy. Do not pull, strap, bind or lift items with this product.



## RT Series - 19 gauge conductor

### Conductor Data

AWG	19 Tin Coated Solid Copper
Diameter	.0358" Nominal
Resistivity	16.85 OHMS per MFT
Tensile Strength	38,500 psi Nominal
Break Strength	38.95 lbs. Nominal
Elongation	30 %

### Conductor Insulation Data

Type	Polyethylene - Black Color
Thickness	.006" Nominal
Overall Thickness	.048" Nominal
Maximum Voltage	300 V Insulated
Dielectric Constant	2.29 @ 1 MHZ

### Core Material

Type	Woven polyester and water blocking polyester yarns
------	--

### Outer Jacket

Type	High Density Polyethylene
------	---------------------------

 <b>WARNING</b>	TRACE-SAFE® Water Blocking Tracer Wire: To promote detection of underground cables and utilities - As with any conductor, it has the potential to transfer electrical energy. Do not pull, strap, bind or lift items with this product.
--	---

NEPTCO warrants that its products will work in a manner consistent with the capabilities described in the data sheet. This warranty shall be void if the product has been tampered with or improperly used. Except for the express warranty and limited remedies described above, NEPTCO disclaims all other warranties including implied warranties. NEPTCO and its authorized agents shall have no other liability beyond the price of the product for damages to a purchaser, including consequential damages occurring in connection with the use or performance of the product.



US Pat. No. 7,932,469; other patents pending

# TRACE-SAFE® WATER BLOCKING CONNECTORS For use with TRACE-SAFE® Water Blocking Tracer Wire

TRACE-SAFE® Water Blocking Connector is compact, durable and easy to use in the field.

<u>Application Includes</u>	<u>P / N</u>
TRACE-SAFE® main line end to end butt splice	T-S 19IL
TRACE-SAFE® main line lateral connection - TRACE-SAFE® main to lateral	T-S 19
TRACE-SAFE® main line butt splice to an existing 10, 12, 14 AWG main line tracer wire	T-S 12-19IL
TRACE-SAFE® lateral to existing 10, 12, 14 AWG main line tracer wire	T-S 12-19

TRACE-SAFE® connectors were evaluated to:

UL 467-2007  
Grounding and bonding equipment  
Chase 9.5 - short time current test

UL 486A - 486B - 2003  
Standard for wire connectors  
Chase 9.3.4 - pullout test

ASTM B117-09 - salt spray fog test

Test report available at [www.trace-safe.com](http://www.trace-safe.com)

Product specification and dimensions:

Material: High strength glass filled polycarbonate  
 Connector dimension: 1 7/16" L x 23/32" W x 23/32" H  
 Water blocking: Filled with sealrite water blocking non-hardening gel  
 Conductor range: 10 AWG - 19 AWG solid copper

US Pat. No. 7,932,469; other patents pending / Trademark

Trace-Safe End to End Butt Splice

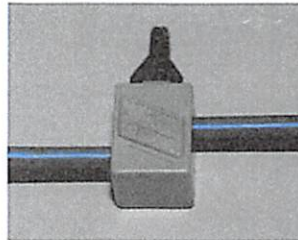

Trace-Safe Main to Lateral

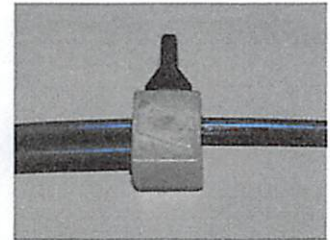

TRACE-SAFE to 12 AWG Butt Splice

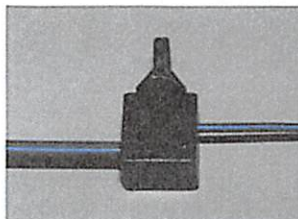

12 AWG Main to Trace-Safe lateral

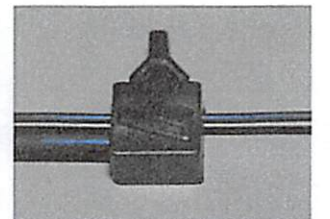

WARNING

TRACE-SAFE® Water Blocking Tracer Wire: To promote detection of underground cables and utilities - As with any conductor, it has the potential to transfer electrical energy. Do not pull, strap, bind or lift items with this product.



Box 2323, 30 Hamlet Street  
 Pawtucket, RI 02861 USA  
 Tel: 401-722-5500 Fax: 401-722-6378  
[www.trace-safe.com](http://www.trace-safe.com)

# 8E.4



## MISCELLANEOUS METER SETTING EQUIPMENT

Rev. 4-14 Shaded area indicates changes



**Brass meter idler**  
Has same end-to-end and thread dimensions as meter. Used to continue service during meter repairs

**H-10887**

Catalog size	5/8	5/8x3/4	3/4	1
Meter size	5/8	5/8x3/4	3/4	1
Length	7-1/2	7-1/2	9	10-3/4
Meter th'd size	3/4	1	1	1-1/4



**Brass locking device (padlock and valve not included)**  
For use on MUELLER® MARK II ORISEAL® Meter Valves - cannot be used on valves having angle lever handles.

**H-14338**

Catalog size	3/4	1
--------------	-----	---



**Water meter increaser**  
Used on threaded ends of 5/8" meter to increase threads to 5/8 x 3/4 or 3/4 meter size (1" thread)  
H-10888: for plain nuts  
H-10888-99002: for saddle nuts

**H-10888N H-10888N-02**

Catalog size	5/8x3/4	5/8x3/4
Meter size	5/8	5/8
Length	11/16"	1"



H-11091



H-11092

**Lock wing sealing device**  
This device is used to detect unauthorized use of valve or stop. Used with lock wings drilled 3/8" or 1/2". The H-11090 is made up of a collar and set screw (H-11091) and a pin (H-11092). The pin is available in 3/8" or 1/2" sizes and the collar with set screw is used on both sizes.



H-11090



**Meter bushing with rubber washer**  
Used on threaded ends of 5/8 x 3/4 or 3/4 meters to adapt to 1" meter thread size (1-1/4")  
H-10889: for saddle nuts  
H-10889-99000: for plain nuts

**H-10889N H-10889N-00**

Catalog size	3/4x1	3/4x1
Meter size	5/8x3/4, 3/4	5/8x3/4, 3/4
Length	1-1/4"	15-16"



**Meter bushing with rubber washer (complete for both ends)**  
Used on threaded ends of 5/8x3/4 meter to adapt to 1" meter thread size (1-1/4") and standard length.



**H-10879N**

Catalog size	5/8x3/4x1	3/4x1
Meter size	5/8x3/4	3/4
Length	2.062	1.313



**Meter coupling washer**  
H-10893: Fiber washer

**H-10893**



**Meter coupling washer**  
H-10895: Rubber washer

**H-10895**

Catalog size	5/8	3/4	1	1-1/4	1-1/2*	2**
Meter size	5/8	5/8x3/4	1	1-1/4	1-1/2	2

\*\* Flange gasket for 1-1/2" and 2" sizes.

Catalog size	5/8	3/4	1	1-1/4	1-1/2*	2**
Meter size	5/8	5/8x3/4	1	1-1/4	1-1/2	2

\*\* Flange gasket for 1-1/2" and 2" sizes.

8E-COPLINGS/MISC.

MUELLER Valves and Couplings are manufactured and tested in accordance with ANSI/AWWA C800. Components in contact with potable water will also comply with latest requirements of the Federal Safe Drinking Water Act.



# HYDRA-STOP®

## 4" - 8" HSF 250™ & HSF 250 Patriot Series™

### Line Stop Fitting Installation Instructions

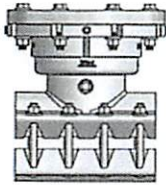

Figure 1

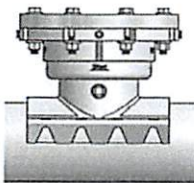

Figure 2

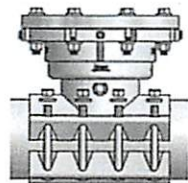

Figure 3

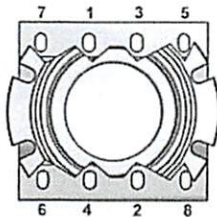

Figure 4

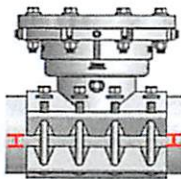

Figure 5

**IMPORTANT:** Read installation instructions before installing Hydra-Stop line stop fittings. Failure to follow installation instructions will void product warranty.

#### INSTALLATION INSTRUCTION STEPS

1. **Confirm bore of temporary gate valve is 8.5 inches.** If the bore of your temporary gate valves is smaller than 8.5 inches immediately call Hydra-Stop technical support (708-389-5111).

2. Inspect the line stop fitting to ensure no damage has occurred during shipment or storage (See Figure 1). Locate and remove completion plug and box containing stainless steel mounting hardware. Store in a clean, safe location.

3. Measure pipe outside diameter where the line stop fitting is being installed to ensure the correct line stop fitting is being used.

4. Thoroughly clean the pipe surface where the line stop fitting will be installed and inspect for flaws, i.e., gouges, protrusions, excessive corrosion, etc. Irregular surfaces should be avoided to assure maximum gasket sealing.

5. Lubricate top and bottom of pipe and mat and branch gaskets with a soap/water solution. Ensure branch gasket is adequately lubricated. Do not use grease or pipe lubricant.

6. Mount the top half of the line stop fitting on the pipe in the position required for permanent installation (See Figure 2). Use a level to ensure the flange is level. Do not rotate the top half of the line stop fitting after it is positioned on the pipe.

7. Install the bottom half of the line stop fitting over the tapered ends of the mat gasket ensuring they are flat and smooth against the pipe surface. Visually inspect gasket to ensure tapered ends are not folded or rolled under themselves. Install stainless steel bolts, washers and nuts (See Figure 3). Finger tighten, ensuring gaps between top half and bottom half of the line stop fitting are the same front to back and side to side (within 1/8"). **NOTE:** It is acceptable to invert the middle two bolts on each side of the 4" line stop fitting to utilize a socket wrench for installation.

8. Using a torque wrench, tighten bolts in proper sequence (See Figure 4). Ensure gaps between top half and bottom half of the line stop fitting are the same front to back and side to side (within 1/8") (See Figure 5). After bolts have been tightened to recommended torque wait 10 minutes to allow the gasket to fully seat and re-tighten bolts to recommended torque.

**NOTE:** 8" fitting has 10 total bolts. Please see figure 6 for bolt torque sequence.

Installation Instructions and Best Practices continued on back

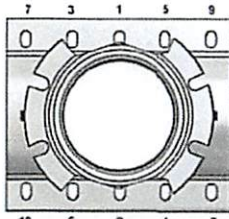

Figure 6



Figure 7

Recommended Torque:

CI / DI Pipe: 115 ft-lbs. PVC Pipe: 55 ft-lbs. AC Pipe: 75 ft-lbs.

9. Perform pressure test to ensure a complete seal between the line stop fitting and pipe (do not use a compressible medium such as air).

Minimum Test Pressure: 1.5 times the system working pressure

Maximum Test Pressure: 375 psi

10. Remove the blind flange and flange o-ring.

11. Check inside of line stop fitting outlet to ensure gasket is properly seated and not protruding where cutter can damage it. Ensure completion plug set pins are flush with I.D. of the flange (See Figure 7).

12. Properly block (support) HSF 250 line stop fitting and ensure pipe joints are properly restrained. Proceed with line stopping operation.

For Questions, please call 800.538.7867

## HYDRA-STOP FITTINGS - INSTALLATION BEST PRACTICES

- Keep nuts and bolts clean and free of debris.
- Adequately lubricate pipe and HSF 250 fitting gaskets with soap/water solution paying special attention to AC pipe. Ensure branch gasket is adequately lubricated. Do not use grease or pipe lubricants.
- Avoid rotating top half of HSF 250 once placed on pipe.
- Tighten nuts equally in no more than 25 ft-lb increments.
- After bolts have been tightened to recommended torque wait 10 minutes to allow the gasket to fully seat and re-tighten bolts to recommended torque.
- Ensure gaps between top half and bottom half of the HSF 250 are the same front to back and side to side (within 1/8").
- Check final torque with a torque wrench to ensure HSF 250 has been torqued to installation specifications.
- Do not use a pneumatic wrench to tighten bolts.
- Hydrostatically pressure test a minimum of 1.5 times the system working pressure or a maximum of 1.5 times the rated working pressure of the HSF 250.
- Block / support the pipe before installing the tapping machine.

**HYDRA-STOP®**

Line Stopping • Line Tapping • Valve Insertion • Training and Support  
 144 Tower Drive, Burr Ridge, IL 60527  
 Phone: 708-389-5111 / Fax: 708-389-5125  
 Toll Free: 1-800-538-7867

An IDEX Water Services & Technology Business 

Call Hydra-Stop for Technical Support at 800.538.7867 and visit us on the web at [www.hydra-stop.com](http://www.hydra-stop.com)

Specifications subject to change without notice.

# HYDRA-STOP®

## 4" - 8" HSF 250™ & HSF 250 Patriot Series™ Push and Pin Completion Plug Installation Instructions

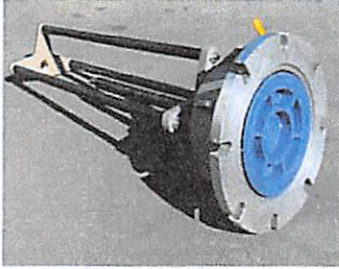

Figure 1



Figure 2

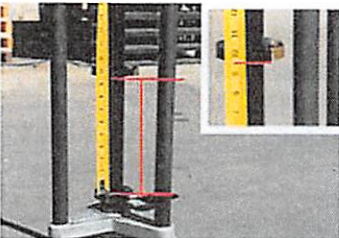

Figure 3

1. Remove cutter from saw mandrel.
2. Install completion plug onto saw mandrel. Grease O-ring with Primolube.
3. Install saw mandrel into the tapping machine housing. Align the bottom of completion plug so that it is flush with the bottom of the tap machine housing (See Figure 1). NOTE: If completion plug is not aligned flush with the bottom of tap machine housing the completion process as outlined in this document will not be successful.
4. Lock the saw mandrel in place using the packing nut assembly thumb screw (See Figure 2).
5. Install stop collar onto the saw mandrel. Set the bottom of the stop collar to 9.5 inches from the top of the packing nut assembly. (See Figure 3). Tighten stop collar.
6. Mount the tapping machine on the gate valve. Use all eight nuts and bolts provided with Hydra-Stopper equipment.
7. Install the drive unit, or the optional completion spacer bar between the feedscrew and saw mandrel. Feed down the feedscrew until drive unit or completion spacer is locked in place. If using the air drive use the 19" feed screw, for hydraulic drive use the 30" feed screw.
8. Slowly open gate valve. Equalize pressure on the top side of the completion plug by using the ball valve on the tapping machine housing.
9. Loosen the packing nut assembly thumb screw and advance the feed screw until the stop collar reaches the top of the packing nut assembly. Please note: it will become tighter when the completion plug o-ring starts to compress. Equalization may be required to fully seat the completion plug.
10. Once the completion plug is fully seated, lock the saw mandrel in place using the packing nut assembly thumb screw. Remove the pin plugs from the fitting flange and store them in a clean, safe location.

Completion Plug Installation Instructions continued on back

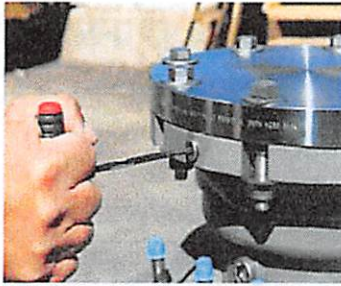

Figure 4

11. Tighten the four set pins in the fitting flange to lock the completion plug in place by turning them clockwise 8-10 turns (See Figure 4). Back off each of the four set pins a half a turn. Install the pin plugs back into the flange.
12. Verify completion plug seal by opening the blow off valve on the tapping housing.
13. Turn the feedscrew counter clockwise to remove the drive unit or completion spacer bar. Loosen the packing nut assembly thumb screw.
14. Disengage the saw mandrel from the completion plug by turning counter clockwise. Pull the saw mandrel into the tap machine housing. Tighten the packing nut thumb screw to secure the mandrel.
15. Close the gate valve.
16. Remove the tapping machine from the gate valve.
17. Remove the gate valve from the fitting top flange.
18. Install the blind flange on the fitting top flange.
19. Clean and inspect installation equipment prior to storage.
20. Order replacement parts, if necessary, to replace lost, damaged or worn componets.

Questions? Please call 800.538.7867

**HYDRA-STOP®**

Line Stopping • Line Tapping • Valve Insertion • Training and Support  
144 Tower Drive, Burr Ridge, IL 60527  
Phone: 708-389-5111 / Fax: 708-389-5125  
Toll Free: 1-800-538-7867

An IDEX Water Services & Technology Business.



Call Hydra-Stop for Technical Support at 800.538.7867 and visit us on the web at [www.hydra-stop.com](http://www.hydra-stop.com)

Specifications subject to change without notice